

RICOH

PRIPORT SS930/SS950

OPERATING INSTRUCTIONS

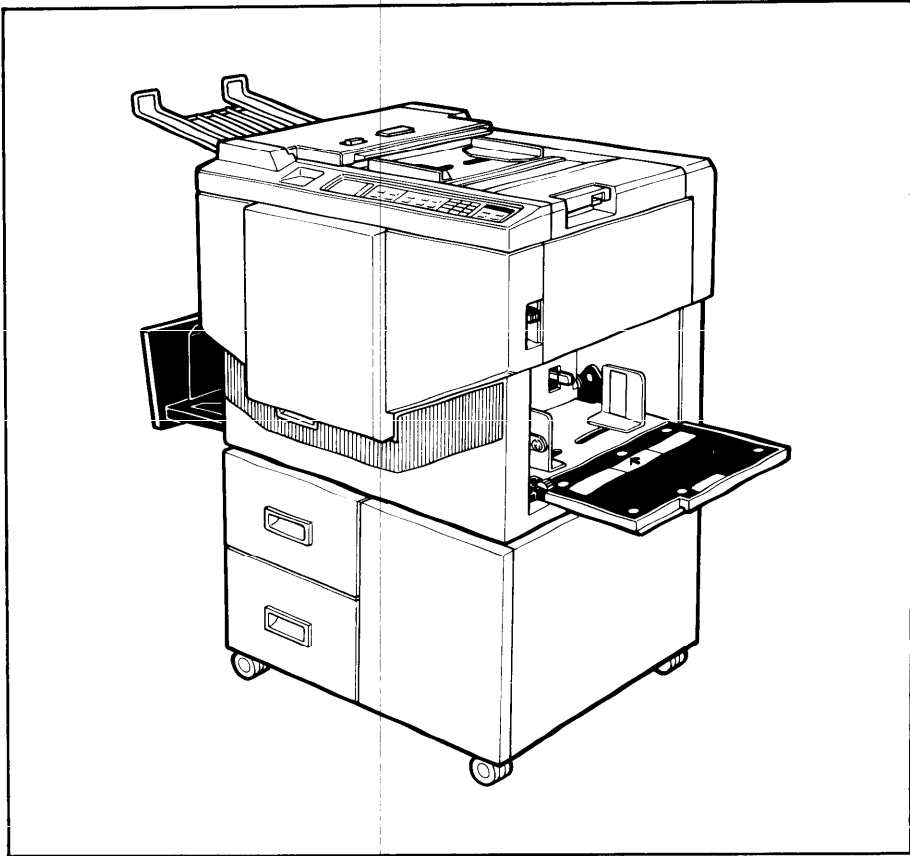

RICOH COMPANY, LTD.

INTRODUCTION

The Ricoh Priport SS930/SS950 is a Stencil duplicator which is carefully manufactured to exacting standards of high performance.

This manual contains detailed instructions on the operation and care of the Priport SS930/SS950. To get the maximum versatility from this machine, all operators should read and follow the instructions in this manual. Please keep this manual in a handy place near the machine.

FEATURES

1. Wide range of reproduction ratios:
4 fixed reproduction ratios (100% plus 3 reduction ratios).
2. 2 single originals can be printed on one sheet of paper.
3. 5 mono color printing with optional drum units.
4. Make-up function allows you to make various prints. (SS950 only)

Note to users in the United States of America

Warning:

This equipment generates, uses, and can radiate radio frequency energy and if not installed and used in accordance with the instruction manual, may cause interference to radio communications. It has been tested and found to comply with the limits for a Class A computing device pursuant to Subpart J of Part 15 of FCC Rules, which are designed to provide reasonable protection against such interference when operated in a commercial environment.

Operation of this equipment in a residential area is likely to cause interference in which case the user at his own expense will be required to take whatever measures may be required to correct the interference.

Note to users in Canada

Warning:

This Digital Apparatus does not exceed the Class A limits for Radio Frequency noise from Digital Apparatus set out in the Radio Interference Regulations of the Canadian Department of Communications.

Remarque concernant les utilisateurs au Canada

Avertissement:

Le présent appareil numérique n'émet pas de bruits radioélectriques dépassant les limites applicables aux appareils numériques de la classe A prescrites dans le Règlement sur le brouillage radioélectrique édicté par le ministère des Communications du Canada.

TABLE OF CONTENTS

GUIDE TO COMPONENTS

- 1. Machine Exterior 2
- 2. Machine Interior 4
- 3. Operation Panel 6

INSTALLATION REQUIREMENTS

- 1. Copier Environment 8
- 2. Access to Machine 9
- 3. Power Connection..... 9
- 4. Ground 9

DO'S AND DON'TS..... 10

ORIGINALS..... 11

PRINTING PAPER 12

OPERATION

- 1. Preparation for Printing..... 13
- 2. Setting the Originals 15
- 3. Printing 16
- 4. Restoring Paper Feed and Paper Delivery Tables..... 17
- 5. Adjusting the Image Position..... 18
- 6. Changing the Paper Size 20
- 7. Printing on Thick or Thin Paper 21
- 8. Printing on Postcard Size Paper 22
- 9. Various Originals..... 23
- 10. Changing the Printing Speed.... 25
- 11. To Stop the Machine During a Printing Run..... 26
- 12. Changing the Drum Unit for Color Printing..... 27
- 13. Printing in Two Colors 29

SPECIAL FUNCTIONS

- 1. Continuous Copying.....30
- 2. Combine 2 Originals.....32
- 3. Various Run Lengths Using the Same Master.....34

REPLENISHING SUPPLIES

- 1. Loading Paper.....35
- 2. Supplying Ink.....36
- 3. Master Roll Replacement37

MAINTENANCE

- 1. Thermal Head Cleaning39
- 2. Platen Cover . Exposure Glass . Mirror.....40

TROUBLESHOOTING

- 1. Indicators41
- 2. When the Misfeed Indicator Lights42
- 3. When the Supply/Exchange Indicator Lights48
- 4. Other Indicators Light.....50
- 5. Dirty Printing51

MISCELLANEOUS

- 1. Operating Cautions.....52

SPECIFICATION53

GUIDE TO COMPONENTS

1. Machine Exterior

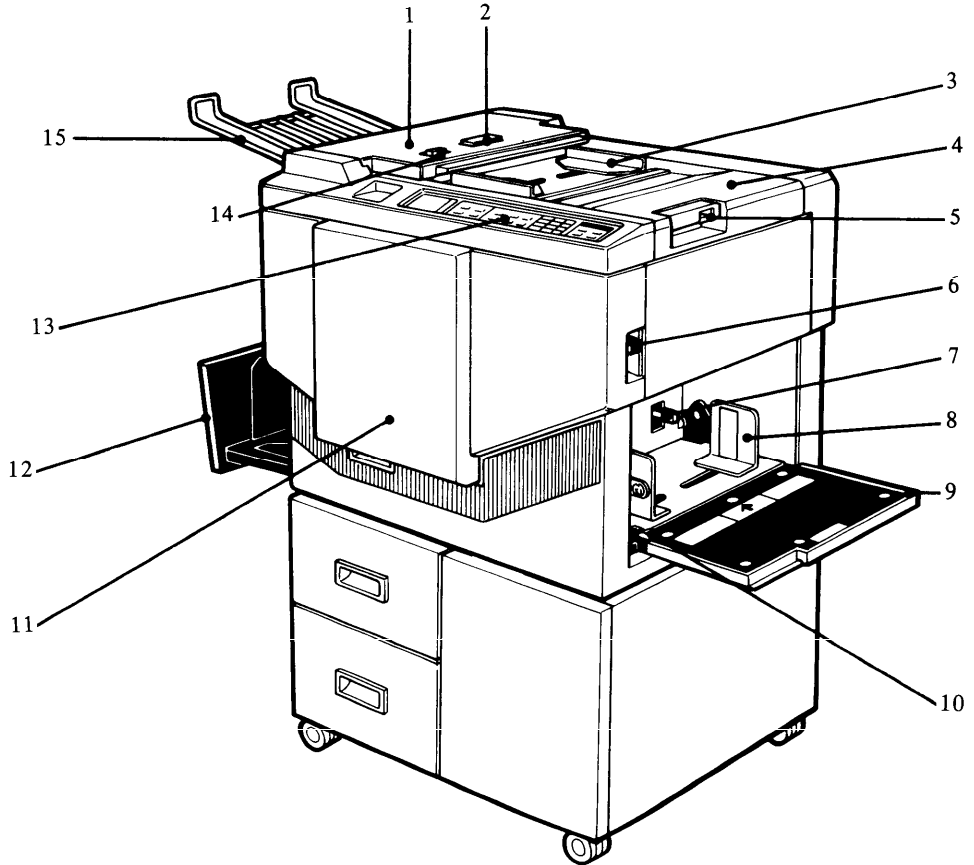

1. ADF Unit	Feeds the original to the printing position automatically.
2. ADF Unit Open Button	Use to open the ADF unit.
3. Original Guides	Adjust these guides to position the originals correctly.
4. Original Table	Place the originals on this table.
5. Original Table Release Lever	Use to open the original table unit to the left for master installation.
6. Feed Roller Pressure Lever	Use to adjust the contact pressure of the paper feed roller according to paper thickness.
7. Separation Roller Pressure Lever	Use to adjust the separation roller pressure to prevent double feed.
8. Paper Feed Side Plate	Use to prevent paper skew.
9. Paper Feed Table	Set the paper on this table.
10. Side Plate Fine Adjusting Dial	Use to shift the paper feed table sideways.
11. Front Door	Open for access to the inside of the machine.
12. Paper Delivery Table	Completed prints are delivered here.
13. Operation Panel	Operator controls and indicators are located here.
14. ADF On/Off Select Switch	When setting originals one sheet at a time, set this switch to the Off position.
15. Original Tray	Originals used to make a master are delivered to this tray.

2. Machine Interior

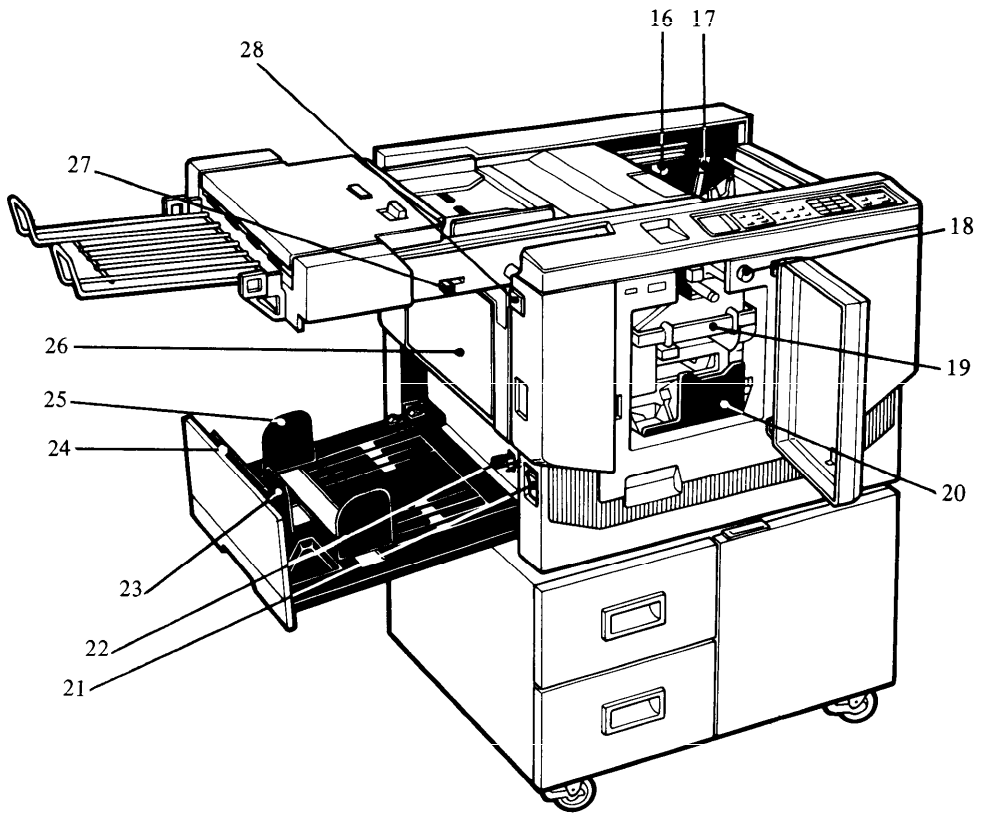

- | | |
|--|--|
| 16. Master Cut Button | Press this button to cut the master paper leading edge after installing a new master roll. |
| 17. Pressure Release Lever | Use to install the master roll, or to clean the thermal head. |
| 18. Drum Rotation Button | Press to replace the drum or to remove misfed paper. |
| 19. Drum Unit | The master paper is wrapped around this unit. |
| 20. Ink Holder | Set the ink cartridge in this holder. |
| 21. Main Switch | Use to turn the power on or off. |
| 22. Wing Guide Release Lever | Use to aid the paper delivery according to paper thickness. |
| 23. Small Size Paper Delivery End Plate (for smaller than A4) | Use to align the leading edge of small-sized (less than A4/LT) prints. |
| 24. Paper Delivery End Plate (for larger than A4) | Use to align the leading edge of prints larger than A4/LT. |
| 25. Paper Delivery Side Plate | Use to align the prints on the paper delivery table. |
| 26. Master Eject Container Cover | Open when removing the master eject box. |
| 27. Printing Density Select Switch | Use to select the printing density according to the type and quality of the original. |
| 28. Master Eject Unit Open Button | Press to remove misfed paper or a misfed master. |

3. Operation Panel

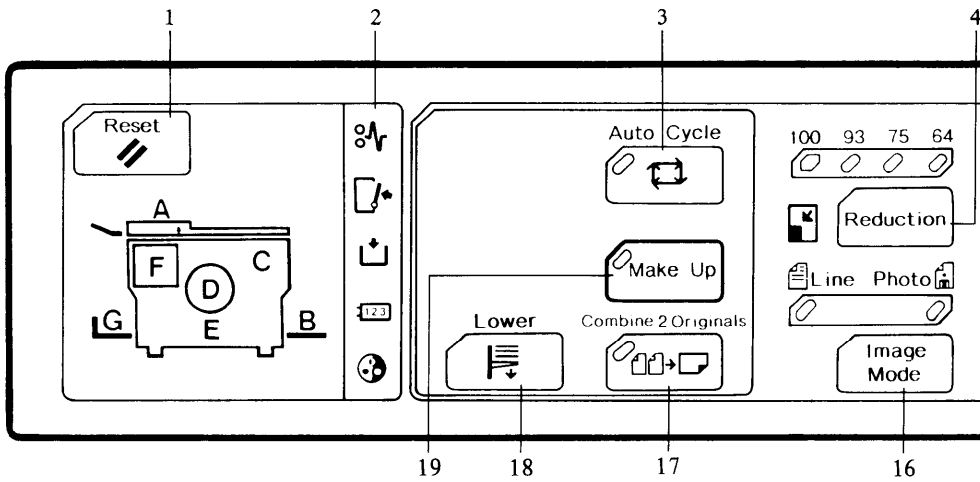

- 1. Reset Key** Press to reset error indicators.
- 2. Indicators** Light or blink when a non-standard condition occurs within the machine (see page 41).
- 3. Auto Cycle Key** Use to automatically process masters and make prints.
- 4. Reduction Key** Press to reduce the image.
- 5. Image Position Keys** Press to shift the image forwards or backwards on the print paper.
- 6. Number Keys** Press to enter the number of prints.
- 7. Counter** Displays the number of prints entered. While printing, it shows the number of uncompleted prints.
- 8. Memory Display** Displays the number of the memory location that will be used to store the number of copies. The print number for up to 10 jobs can be stored at once.
- 9. Print Start Key** Press to start printing.
- 10. Master Making Key** Press to make a master.
- 11. Proof Key** Press to make trial prints or extra prints.

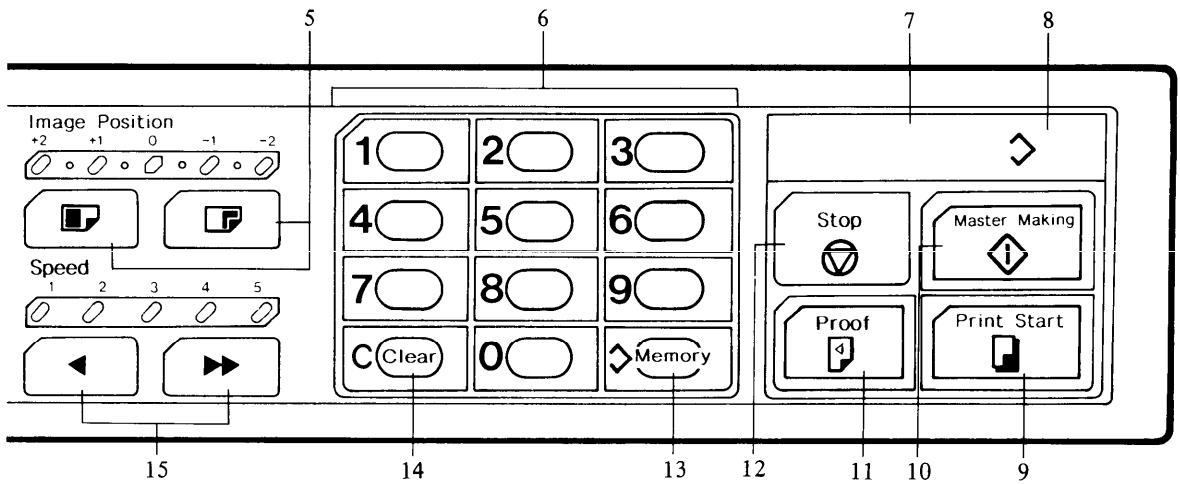

12. Stop Key

Press to stop the machine operation. The machine will continue operation when the Print Start key or Master Making key is pressed.

13. Memory Key

Use to select memory location number. (1 - 10)

14. Clear Key

Press to change the number set in the counter. Also use to change the make-up mode (SS950 only). This key can be used only after the machine stops operation.

15. Speed Keys

Press to adjust the rotation speed of the machine according to the type of image and printing paper.

16. Image Mode Key

Press to select line mode or photo mode according to the type and quality of the original.

17. Combine 2 Originals Key

Press to combine two originals onto one print image.

18. Lower Paper Feed Table Key

Press to lower the paper feed table.

19. Make-up Key

Press to use the make-up function (SS950 only).

INSTALLATION REQUIREMENTS

1. Machine Environment

The installation location should be carefully chosen because environmental conditions greatly affect the performance of a machine.

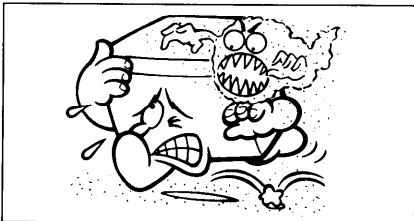
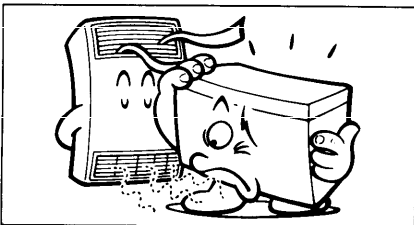
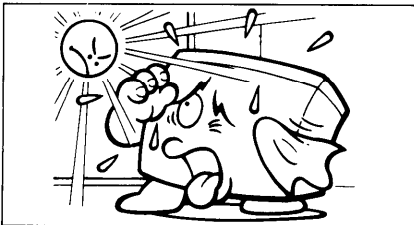
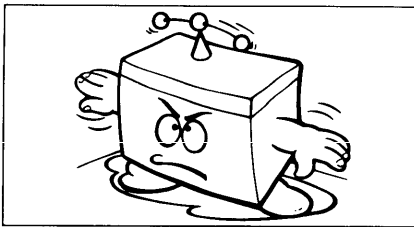
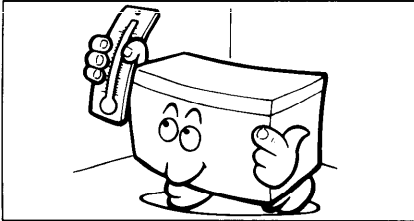

- Optimum environmental conditions -
 - Temperature: 10 – 30°C (50 - 86°F)
 - Humidity: 20 – 90% RH
 - Ventilation: Well-ventilated and wide room.
 - On a strong and level base (a sturdy desk, etc.).
 - The machine must be level within 5 mm (13/64") both front to rear and left to right.

- Environments to avoid -
 - Direct sunlight or strong light

 - Locations directly exposed to the cool air from an air conditioner or reflected heat from a space heater. (Sudden temperature changes low to high or vice versa may cause condensation within the machine.)
 - Dusty areas.

2. Access to Machine

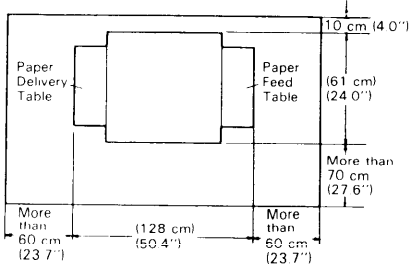

Place the machine near a power source, providing clearance as shown to the left.

3. Power Connection

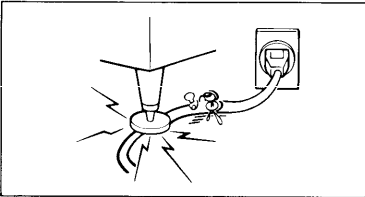
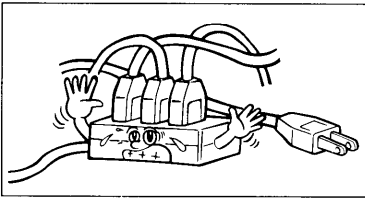
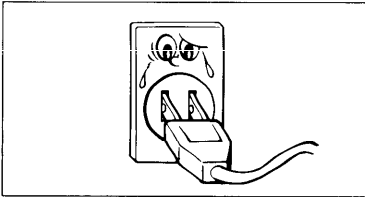
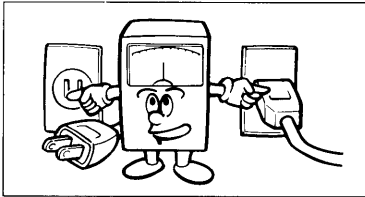

- Connect the power cord to a power source as follows.

120 V, 60 Hz more than 5.5 A
220/240V, 50/60 Hz more than 2.7 A

- Make sure the plug is firmly inserted in the outlet.
- Avoid multiwiring.
- Do not pinch the power cord.

4. Ground

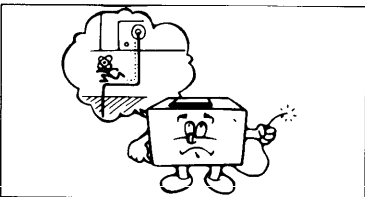

- Be sure to ground the machine. Never connect the ground line to a gas pipe.

DO'S AND DON'TS

- Operating Cautions -

1. While Printing :
 - Do not turn off the main switch.
 - Do not unplug the power cord.
 - Do not open the front cover.
 - Do not move the machine.
2. Keep corrosive liquids, such as acid, off the machine.
3. Do not allow paper clips, staples, or other small objects to fall inside the machine off.
4. Always turn the machine off when you have finished printing for the day.
5. Do not touch print paper if your fingers are wet or oily; fingerprints may appear on prints.

- GENERAL CAUTIONS -

1. Do not modify or replace any parts other than the ones specified in this manual.
2. When the machine will not be used for long periods, disconnect the power cord.
3. If the machine must be transported by vehicle, please contact your dealer.
4. Do not operate the machine with any covers off.

ORIGINALS

You can use the following type of originals.

- Size-

- Thickness -

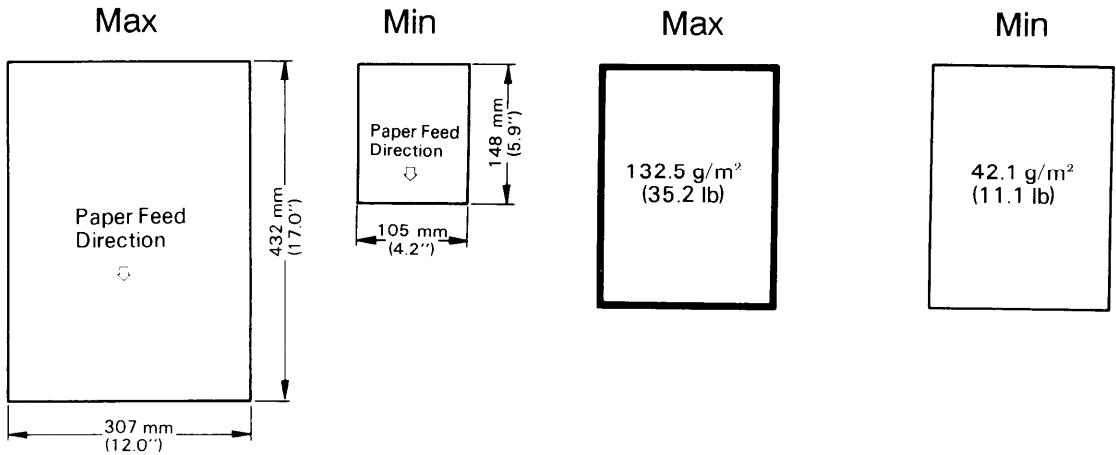

Cautions for original feeding.

To prevent an original misfeed or a machine malfunction, note the following cautions.

- Remove paper clips or staples from the originals.
- Correct curl or bend of originals before printing.
- Make a copy and use the copy as an original for the following types of originals.

Carbon coating

Bent or
Damaged

With glue

Paste-up

Originals with
binding holes

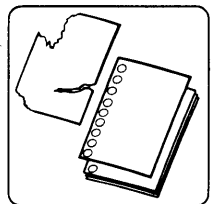
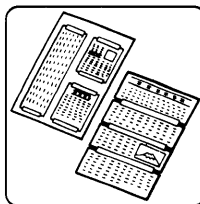
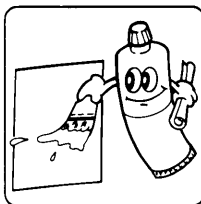
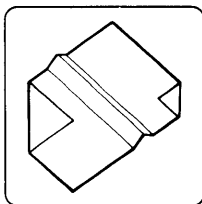
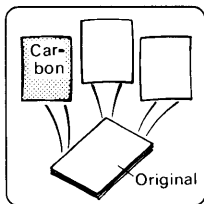

- Select the SADF mode when feeding transparencies or tracing papers as originals. (Set one original at a time.)

PRINTING PAPER

You can use the following types of paper as printing paper.

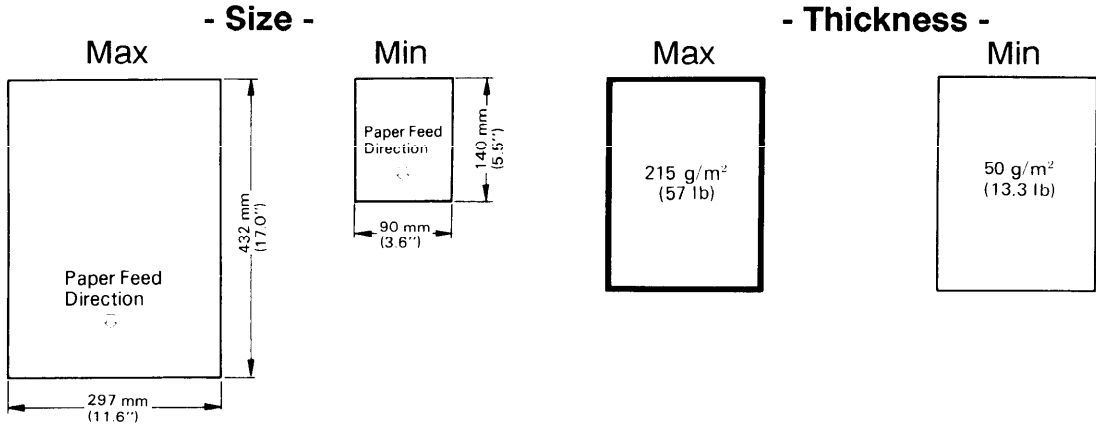

Avoid using the following kinds of paper.

- Roughly-cut paper
- Paper of different thicknesses in the same stack
- Buckled or curled paper
- Short grained paper

Print Size

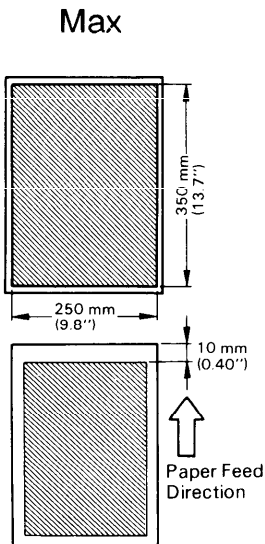

A3 (DLT) size can be fed as an original or printing paper, but the maximum printing size is 250 x 350 mm (9.8" x 13.7").
Set 82 % or 71 % (75% or 64%) reduction when you print the whole image of A3 (DLT) size originals.

Note:

The first 10 mm after the leading edge cannot be printed. Make sure the leading edge margin is more than 10 mm.

The position of center and the leading edge of the image do not change in any reduction mode.

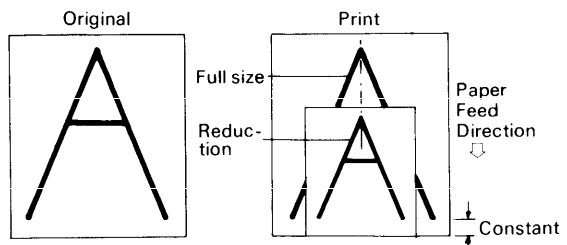

OPERATION

1. Preparation for Printing

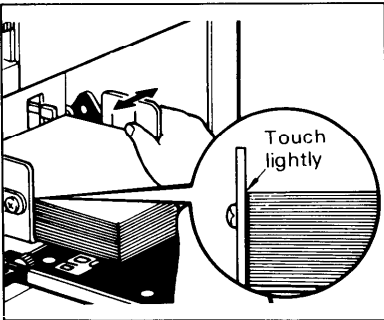
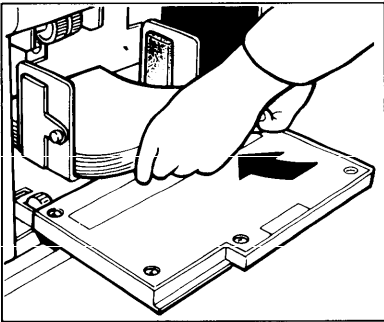
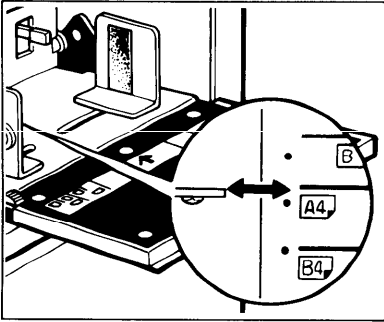
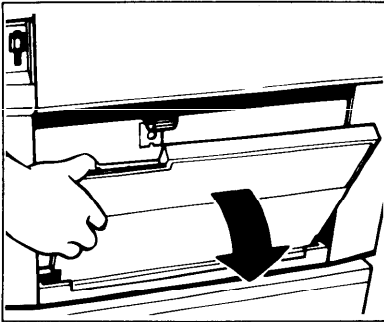

1. Open the paper feed table carefully.
2. Adjust the paper feed side plates to match the paper size.
3. Place the paper on the paper feed table.
 - Correct the paper curl before setting the paper.

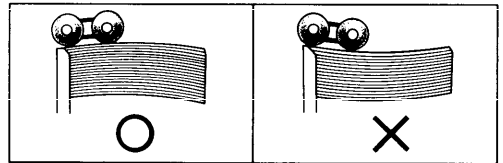

4. Make sure that the paper feed side plates contact the paper lightly.

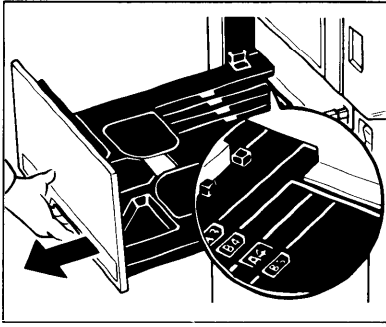

5. Open the paper delivery table.
 - Set the paper delivery table for the paper size, using the size scale on the table.

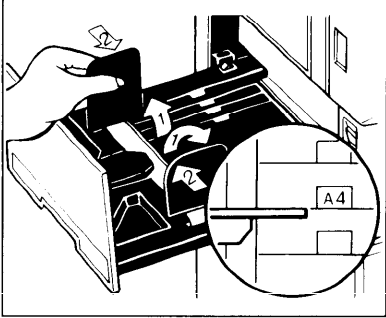

6. Lift the paper delivery side plates and adjust them to the paper size.

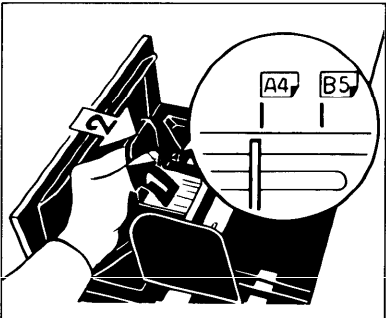

7. If you want to use paper smaller than A4 (LT), lift the small size paper delivery end plate.

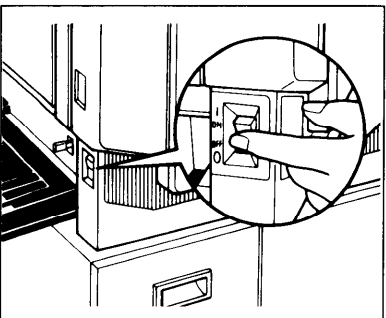

8. Turn on the main switch.

2. Setting the Originals

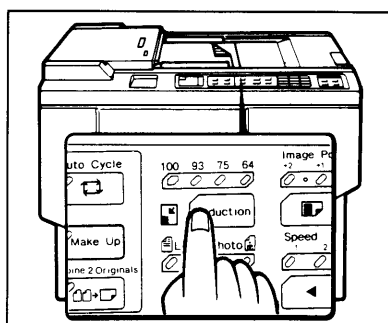
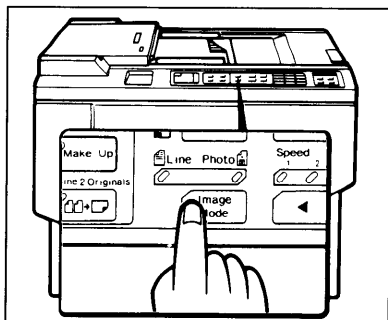
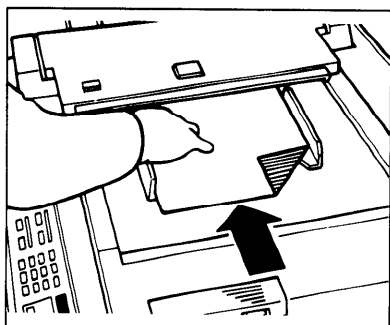
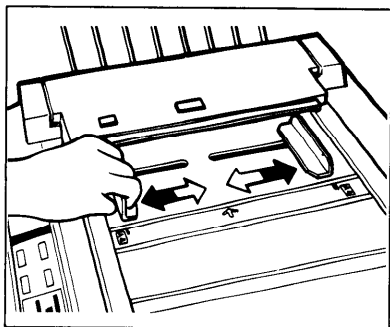

1. Adjust the original guides to the size of the original.
2. Insert the original face down on the original table until it stops.
 - Up to 10 originals can be inserted at one time.
 - Do not insert different size originals at the same time.
3. Select the image mode using the **Image Mode** keys.
 - Use the line mode when the original is printed matter.
 - Use the photo mode when the original contains photos or colored images.
 - The line mode is automatically selected when the main switch is turned on.
4. If reduced prints are desired, set the reproduction ratio using the **Reduction** key.

The reduction ratio will change as follows:

120 V version
93% → 75% → 64%
220/240 V version
93% → 82% → 71%

 - If the original is A3 (DLT), it is impossible to print in 100% mode. Select 82% or 71% (75% or 64%).
 - 100% mode is automatically selected when the main switch is turned on.

3. Printing

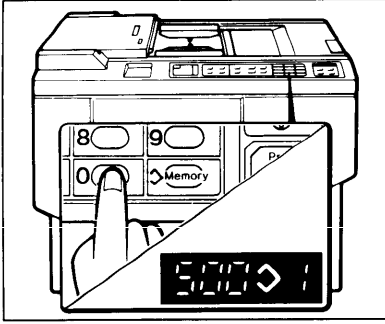

1. Enter the number of prints required using the **Number** keys.
 - Up to 9999 prints can be entered at one time.
 - To change the number entered, press the **Clear** key and then enter the new number.

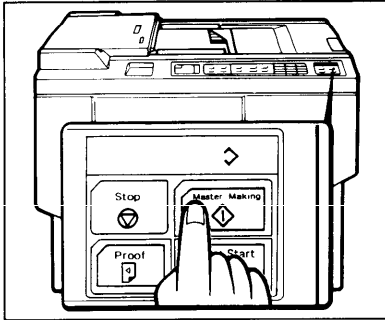

2. Press the **Master Making** key.
 - The original is fed, and the trial print is delivered to the paper delivery table. Check the image position. (See page 18 to 19.)

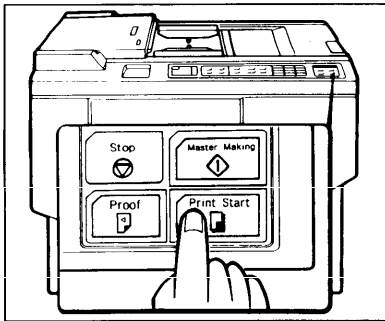

3. Press the **Print Start** key.
 - The number of prints set in the counter are made and the machine stops.
 - The same number of prints are input automatically after printing is completed.
 - If the next original has been set in the original table before the machine stops, that original is fed automatically and a trial print is delivered to the paper delivery tray. Check the image position. (See page 18 to 19.)

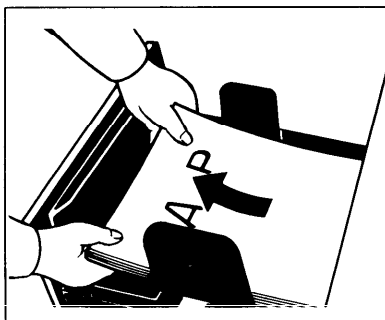

4. Remove the prints from the paper delivery table.

4. Restoring Paper Feed and Paper Delivery Tables

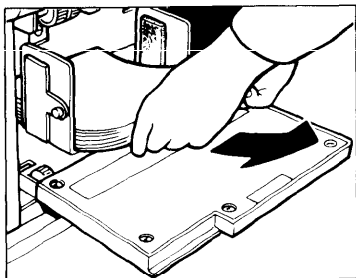

1. Remove the paper from the paper feed table.
 - The paper feed table will lower automatically.

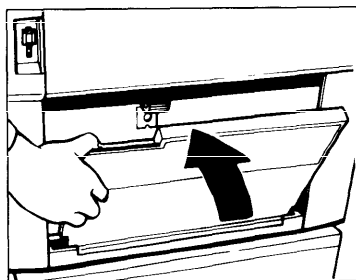

2. Return the paper feed table to its original position.

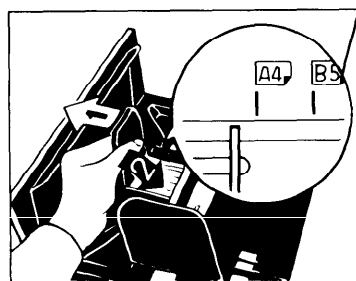

3. Return the small size paper delivery end plate to its original position

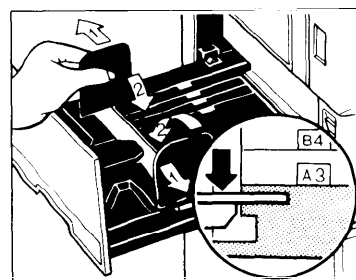

4. Return the paper delivery side plates to their original position.
 - Make sure that the paper delivery side plates do not touch the small size paper delivery end plate.

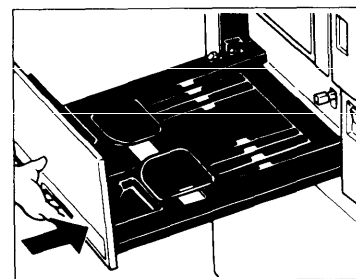

5. Slide in the paper delivery table.
6. Turn off the main switch.

5. Adjusting the Image Position

If the image position is not correct, adjust before you start printing.

- Shifting the image position forward

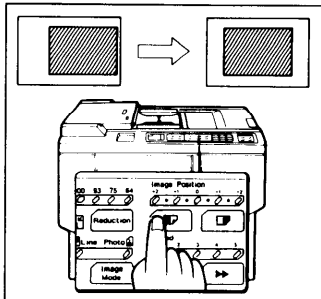

1. Press the left **Image Position** key.
 - When you shift the image forwards, leave a margin (more than 10 mm/0.40") at the leading edge.

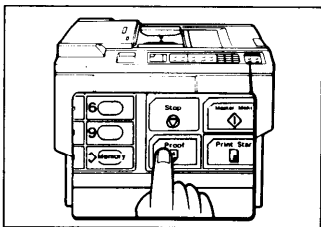

2. Press the **Proof** key. Check the image position again.

- Shifting the image position backward

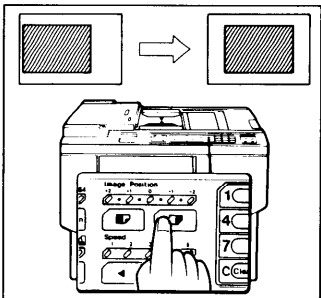

1. Press the right **Image Position** key.

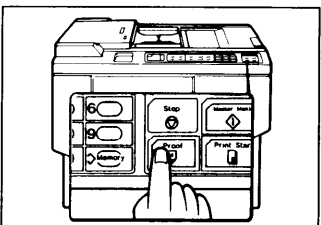

2. Press the **Proof** key. Check the image position again.

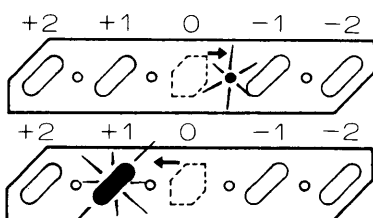

Note:

- The left and right **Image Position** keys shift the image about 1mm/0.04" each time they are pressed.
- When the indicator changes from 0 to +1 (-1), the image position shifts about 10mm/0.40" (-10mm/-0.40").

- Shifting the image to the right

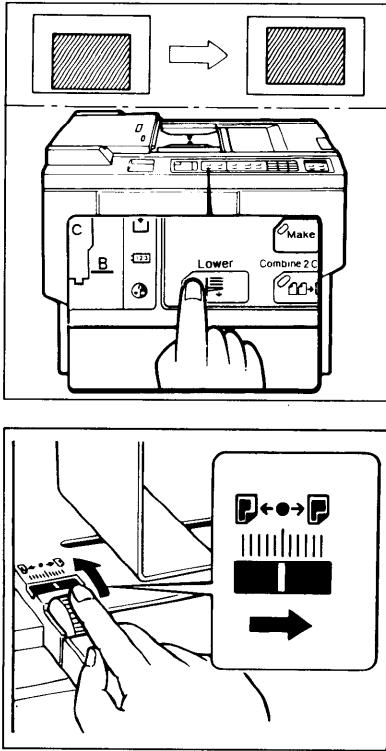

1. Press the **Lower Paper Feed Table** key.
2. Turn the side plate fine adjusting dial as shown in the illustration.
 - You can shift the image position up to 10 mm from the center. Each division on the scale is 2 mm.
3. Press the **Proof** key. Check the image position again.
 - If the image position is not set correctly, do steps 1 - 3 again.

- Shifting the image to the left

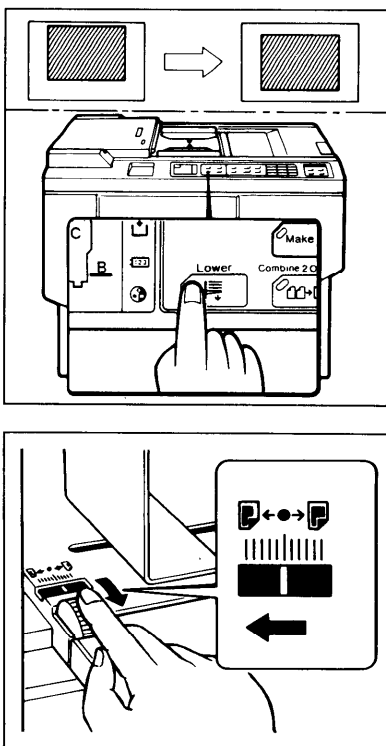

1. Press the **Lower Paper Feed Table** key.
2. Turn the side plate fine adjusting dial as shown in the illustration.
 - You can shift the image position up to 10 mm from the center. Each division on the scale is 2 mm.
3. Press the **Proof** key. Check the image position again.
 - If the image position is not set correctly, do steps 1 - 3 again.

6. Changing the Paper Size

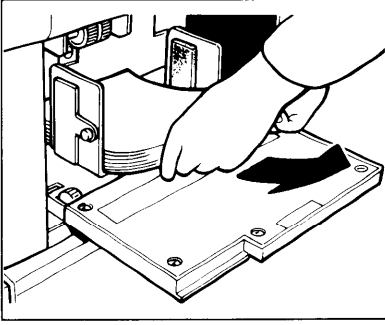

1. Remove the paper from the paper feed table.
 - The paper feed tray will lower automatically.

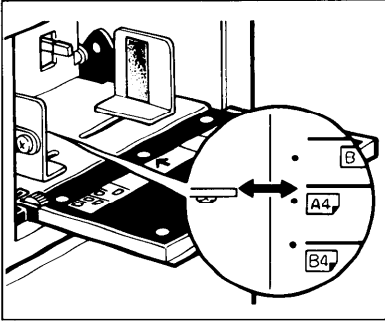

2. Adjust the paper feed side plates to match the paper size.

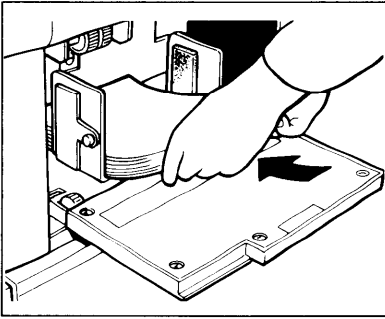

3. Place the paper on the paper feed table.
 - Correct the paper curl before setting the paper.

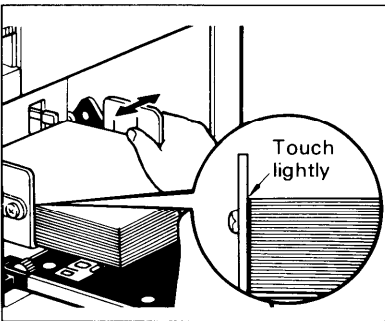
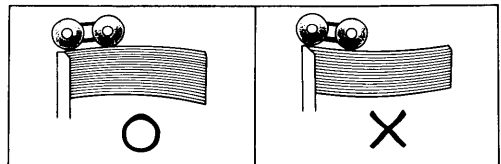

4. Adjust the paper delivery side plates and the paper delivery end plate. (See page 14).
 - Make sure that the paper feed side plates contact the paper lightly.

7. Printing on Thick or Thin Paper

When you make prints on thick or thin paper, do the following steps.

- Printing on thick paper

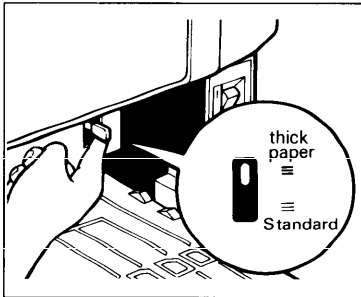
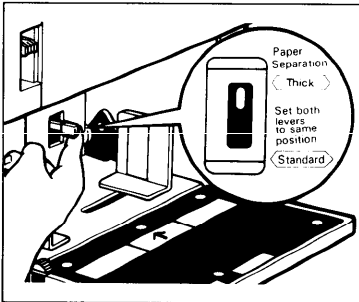
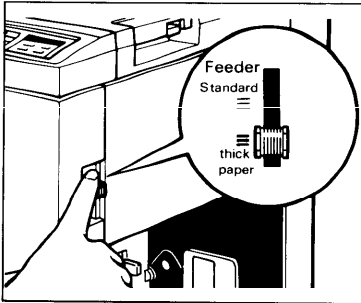

1. Push down the feed roller pressure lever.
 - Thick paper : 132.5 to 215 g/m² (35.2 to 57 lb)
 - In the case of paper smaller than B5/5 1/2" x 8 1/2" and heavier than 132.5 g/m² (35.2 lb), move the feed roller pressure lever to the standard position.

2. Push the separation roller pressure levers up to the thick paper position.

3. Push up the wing guide release lever to the thick paper position.
4. Make prints. (See page 13 to 17.)

- Printing on thin paper

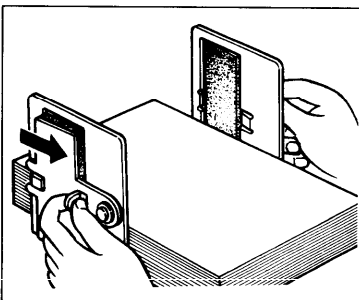

1. Set the side pads (Move the side pad levers to the right).
 - Thin paper : lighter than 51.2 g/m² (13.6lb)
2. Make prints. (See page 13 to 17.)

8. Printing on Postcard Size Paper

- Postcard size original

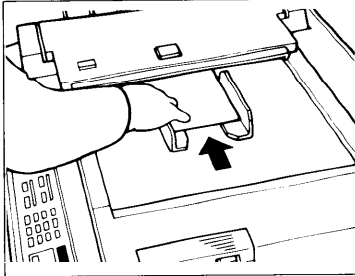
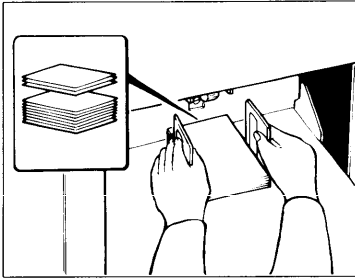

1. Place the postcard sized paper on the paper feed table.
 - Make sure that the paper feed side plates contact the paper lightly.
2. Set the original guides to match the postcard size original.
3. Insert the original face down into the original table until it stops.
4. Make the prints. (See page 13 to 17.)

The original is larger than postcard and the image is postcard size.

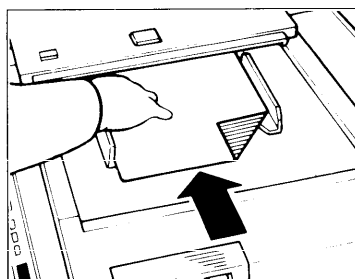
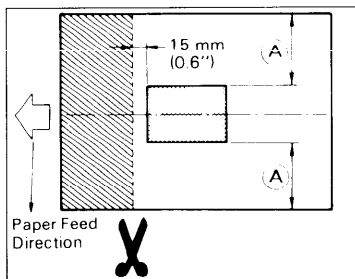
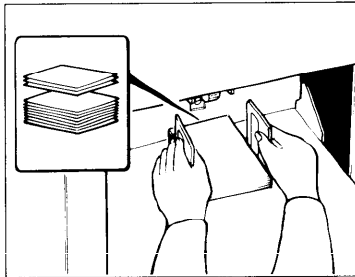

1. Place the postcard size paper on the paper feed table.
 - Make sure that the paper feed side plates contact the paper lightly.
2. Cut the leading edge of the original as shown in the illustration. Leave 15 mm/0.6" margin when you cut.
3. Insert the original face down into the original table until it stops.
4. Make the prints. (See page 13 to 17.)

9. Various Originals

If you want to make prints using a light or dark original, change the printing density using the printing density select switch.

- Light image originals – Change the printing density to a darker setting
- Heavy image originals – Change the printing density to a lighter setting

NOTE:

- Make sure that the printing density select switch clicks into position.
- Return the printing density select switch to its original position after printing.

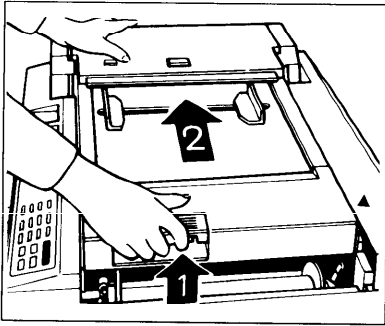

1. Open the original table.
 - Lift the original table release lever and slide the original table to the "▼" mark.

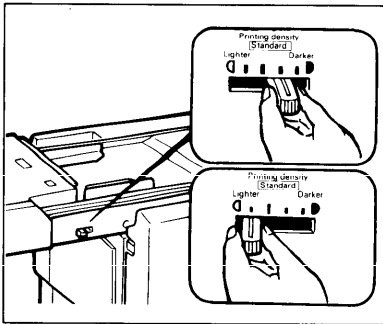

2. Adjust the printing density to match the type and quality of the original using the printing density select switch.
3. Return the original table to its original position.
4. Make the prints. (See page 13 to 17.)

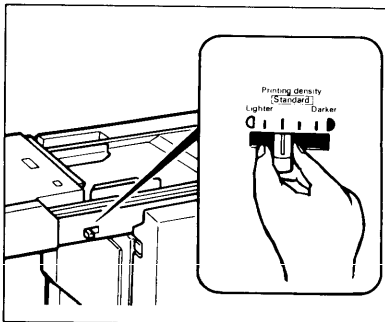

5. After printing, return the printing density select switch to the standard position.

When using originals that are easily smeared, cancel the ADF mode.

NOTE:

- Return the ADF On/Off select switch to the "On" position after printing.
- When making a master using easily smeared originals, set one original at a time.

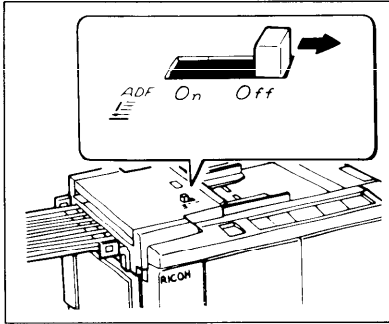

1. Push the ADF On/Off select switch to the right to cancel the ADF mode.

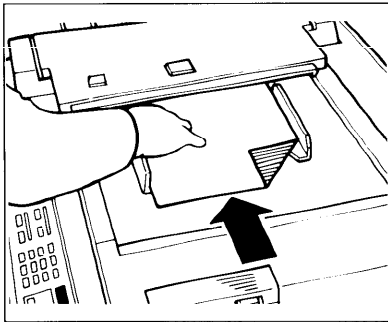

2. Insert one original face down into the feeder till the original is fed automatically.
3. Make prints. (See page 13 to 17.)

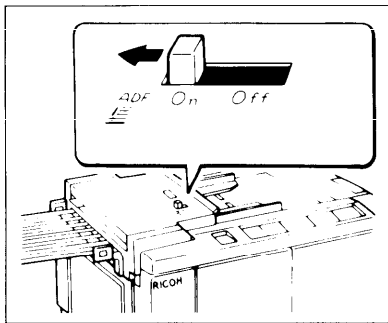

4. After printing, return the ADF On/Off switch to the standard position ("On" position).

10. Changing the Printing Speed

Use the Speed key to adjust the rotation speed of the machine according to the image density and printing paper.

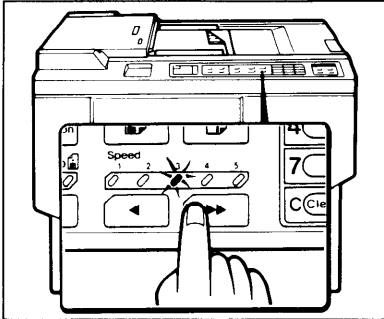

1. Press the **Speed** key. To increase speed, press the "▶▶" key. To reduce speed, press the "◀◀" key. The printing speed will be changed as follows:

Step 1	40 sheets/min
Step 2	60 sheets/min
Step 3	80 sheets/min
Step 4	100 sheets/min
Step 5	120 sheets/min

 - When the main switch is turned on, step 3 (80 sheets/min) is selected automatically.
 - The faster the printing speed becomes, the lighter the printing density is. If darker prints are required, set the printing speed lower.

11. To Stop the Machine During a Printing Run

If you want to stop the machine during a print run and print the next original, do the following procedure.

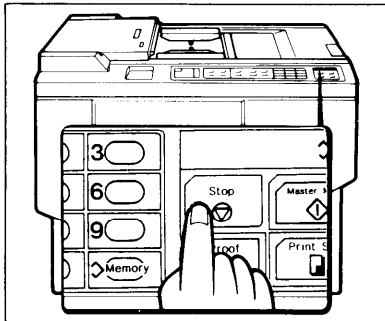

1. Press the **Stop** key.
2. Set the new original.
3. Re-enter the number of prints and press the **Master Making** key.

If you want to change the number of prints entered or to check the completed prints.

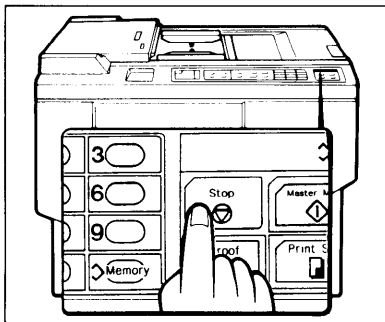

1. Press the **Stop** key.

Change the number of prints or check the completed prints.

- When you change the number of prints, you can re-enter the number using the **Number** keys after pressing the **Stop** key.

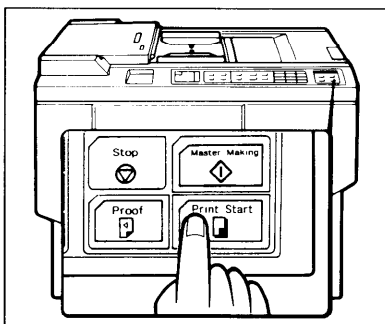

2. Press the **Print Start** key.

12. Changing the Drum Unit for Color Printing

Color drum units (red, blue, green, and brown) are available as options in addition to the standard black. For making color prints, a separate drum unit is necessary for each color.

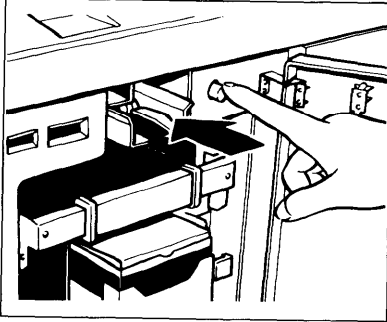

1. Open the front door.
 - Make sure that the lamp of the drum rotation button lights. If this lamp is not lit, press the drum rotation button until the beeper sounds.

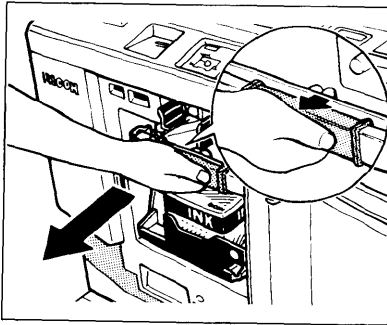

2. Pull out the drum unit handle while pressing the release bar inside the green handle.

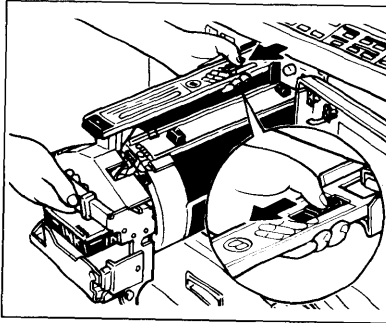

3. Hold the rail on the drum and slide out the drum while pressing the release slide to the front.

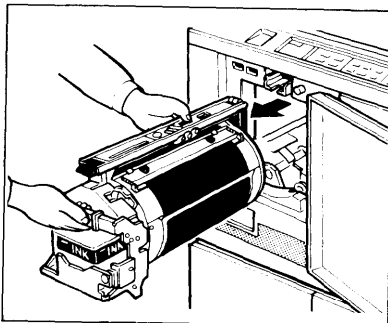

4. Remove the drum unit from the machine while holding the upper drum stay.
 - Be careful not to let the drum unit fall.

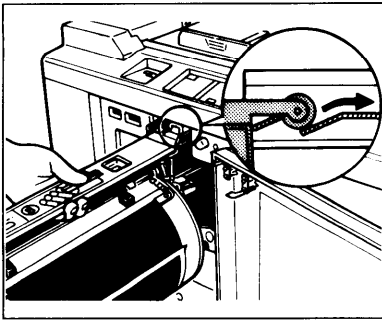

5. Insert the color drum unit along the guide rail.

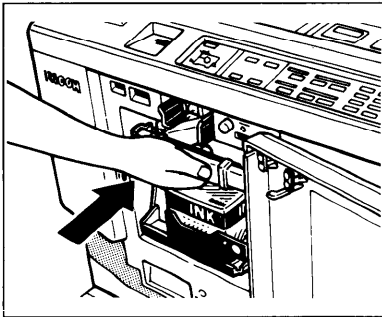

6. Slide in the drum unit until the drum unit locks securely.
7. Close the front door.
 - Make sure that the Cover Open indicator turns off, and the Color Drum indicator lights.
 - If the Cover Open indicator does not turn off, check that the drum unit is set correctly.

13. Printing in Two Colors

After printing in black, you can print in color on the same side of the print.

- You cannot print in two colors at one time.

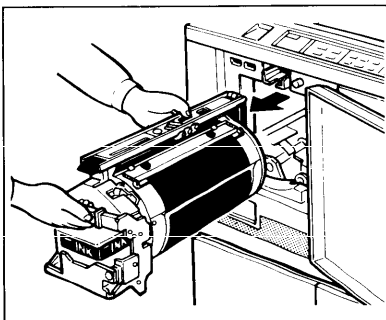
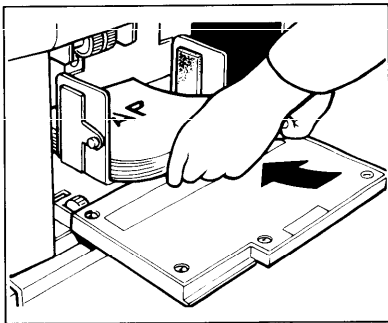
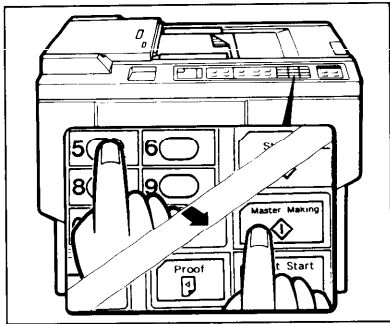
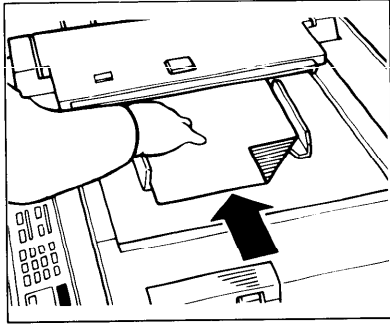

- Prepare the two originals.
Set the first original on the original table.

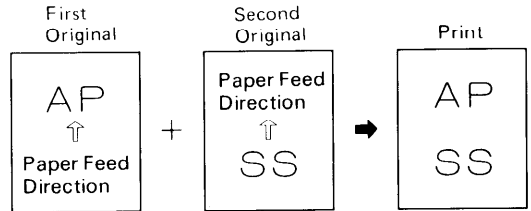

- Enter the number of prints using the **Number** keys.
- Press the **Master Making** key.
 - The original is fed, and the trial print is delivered to the paper delivery table. Check the image position. (See page 18 to 19).

- Press the **Print Start** key.
- Remove the prints from the paper delivery table and set them on the paper feed table again as shown in the illustration.

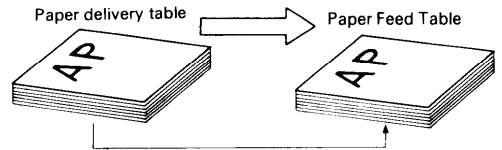

- Exchange the drum unit. (See page 27 to 28.)
- Set the second original and press the **Master Making** key. Check the image position. (See page 18 to 19.)
- Press the **Print Start** key.

SPECIAL FUNCTIONS

1. Continuous Copying

- To prevent original misfeeds, do not set different size originals at the same time.
- Do not set more than 10 originals at one time.

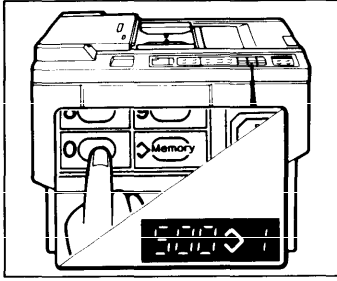

1. Turn on the main switch.
2. Enter the number of prints for the first run using the **Number** keys.

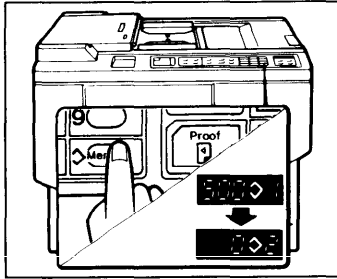

3. If the number of prints for each original is not the same, do the following steps.
 - 1) Press the **Memory** key.

The number for the first run is stored in Memory 1.

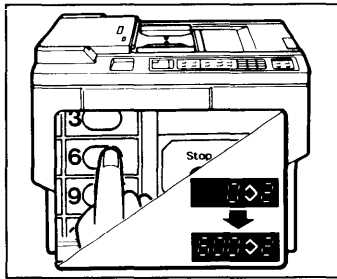

- 2) Enter the number of prints for the second run using the **Number** keys.

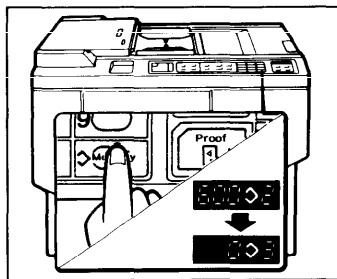

- 3) Press the **Memory** key. The number for the second run is stored in Memory 2.

Repeat the above procedure until you complete the settings.

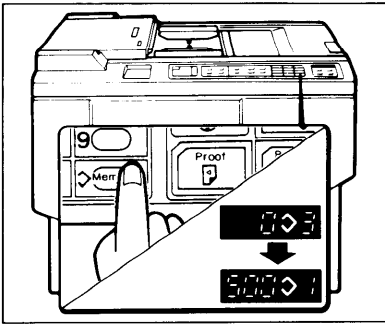

4) Press the **Memory** key again.
The Memory returns to Memory 1.

- If you store print number for 10 originals, the memory number returns to 1. It is not necessary to press the **Memory** key again.

4. Check that the ADF on/off select switch in the "On" position.

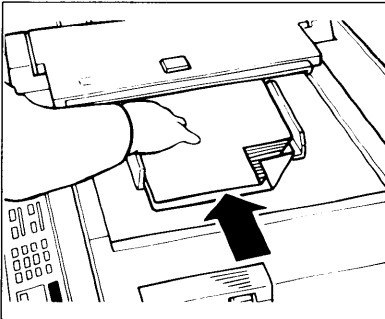

5. Set the originals face down on the original table.

- 10 originals can be set at one time.
- The originals are fed from the bottom. Make sure that the original for the first run (Memory 1) is set on the bottom.

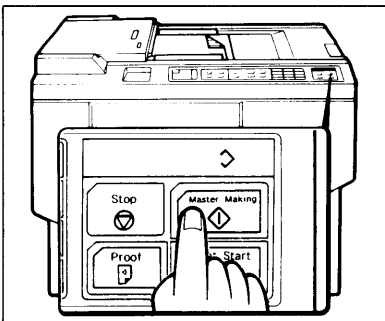

6. Press the **Master Making** key. Check the image position of the trial prints. (See page 18 to 19.)

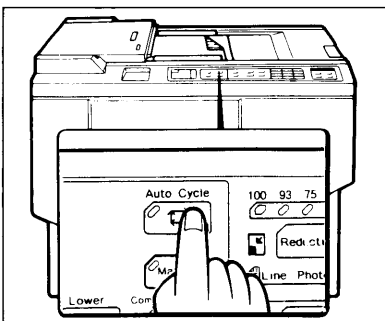

7. Press the **Auto Cycle** key.

- The indicator of the Auto Cycle key will light.
- After pressing the Auto Cycle key, you cannot make trial prints.

8. Press the **Print Start** key.

9. After the first run is finished, remove the prints from the paper delivery table.

10. The second print run begins automatically.

11. The Machine will stop automatically after all the print runs stored in the memory are completed.

2. Combine 2 Originals

You can print 2 separate originals on the single sheet of paper.

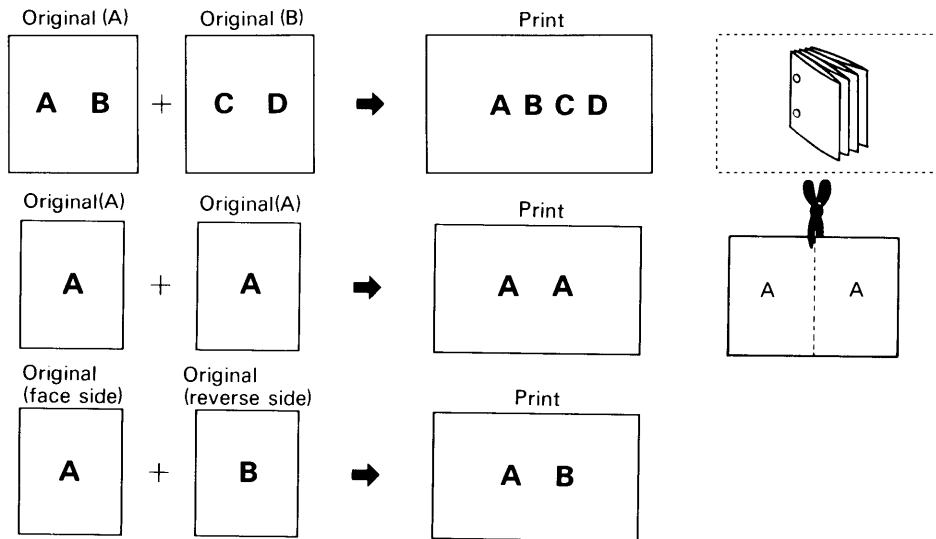

Note:

If you print A4/8 1/2" x 11" originals on the one sheet of paper, set the reduction ratio to 82% / 75% or 71% / 64%. When using A4/8 1/2"x11" originals, you cannot use this mode with 93% or 100%.

- Use paper greater than the combined image area of the 2 originals.

For Example:

220/240V version (120V version)

Original		Ratio	100%	93%	82%(75%)	71%(64%)
B5 (HLT)	+	B5 (HLT)	B4 (LT)	B4 (LT)	A4 (LT)	B5 (HLT)
A4 (LT)	+	A4 (LT)	—	—	B4 (Legal)	A4 (LT)

- If you set an original larger than as shown in the following table, the Combine 2 Originals mode is cancelled automatically.

120V version			220/240V version		
100%	→	5 1/2"x8 1/2"	100%	→	B5
93%	→	5 1/2"x8 1/2"	93%	→	B5
75%	→	8 1/2"x11"	82%	→	A4
64%	→	8 1/2"x11"	71%	→	A4

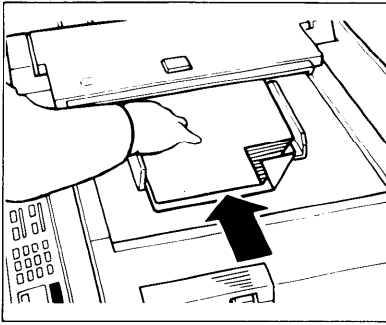

1. Set the 2 originals face down and with the top toward the operating side.
 - The first original fed will be printed on the leading part of print.

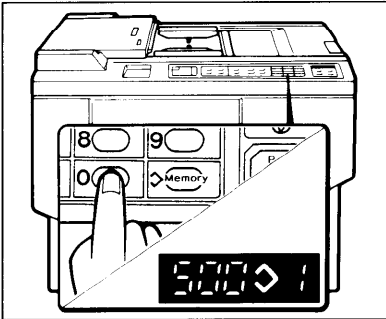
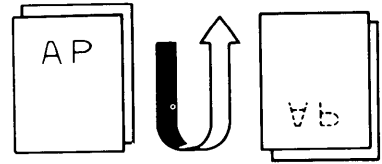

2. Enter the number of prints using the **Number** keys.
3. Check the print paper size.

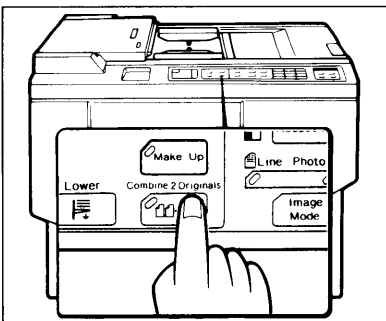

4. Press the **Combine 2 Originals** key.
 - The indicator of the **Combine 2 Originals** key will light.

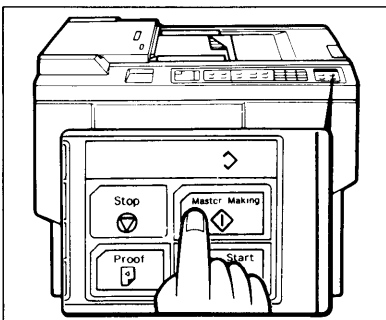

5. Press the **Master Making** key.
 - After the master making for the first original is finished, the second original is fed automatically.
 - If you set only one original, the beeper sounds after master making for the first original is finished. Set the second original and press the **Master Making** key.
 - If you set only 2 originals, the combine 2 originals mode will be cancelled automatically after master making for the second original.
6. Check the image position of trial prints and press the **Print Start** key.

3. Various Run Lengths Using the Same Master

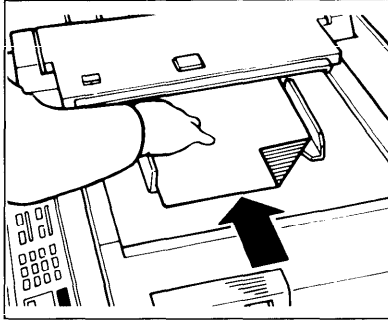

1. Set one original on the original table.

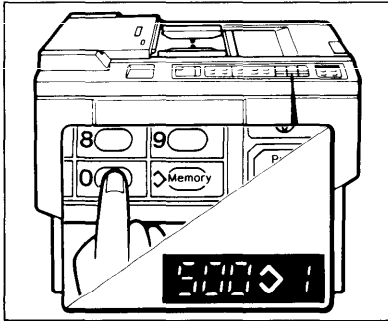

2. Enter the number of prints for the first run using the **Number** keys.
3. Press the **Master making** key. Check the image position of trial prints. (See page 18 to 19.)

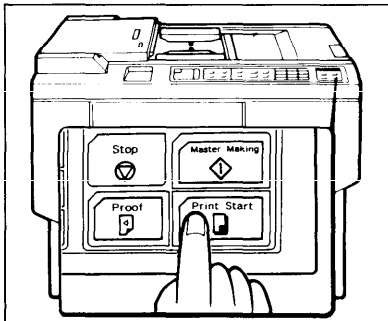

4. Press the **Print Start** key.
5. Remove the prints from the paper delivery table.

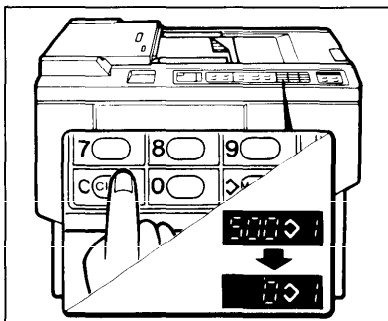

6. Press the **Clear** key to return the counter to "0".
7. Enter the number of prints for the second run using the **Number** keys.
8. Press the **Print Start** key.
9. Remove the prints from the paper delivery table.
10. Repeat steps 6-9 until printing is completed.

REPLENISHING SUPPLIES

1. Loading Paper

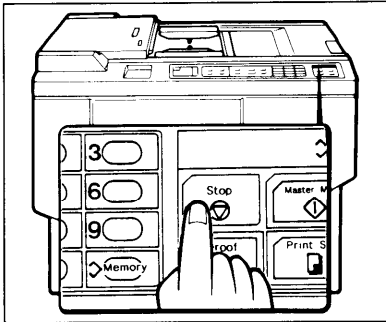

1. Press the **Stop** key.

- This step is necessary only if you want to pause a print run to replenish paper.

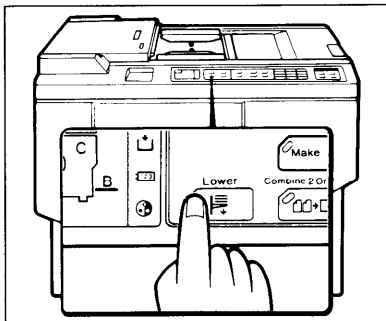

2. Press the **Lower Paper Feed Table** key.

- The paper feed table will lower automatically when the printing paper runs out.
- When the paper feed table lowers, the top sheet may remain between the feed rollers. In this case, remove the top sheet by hand.

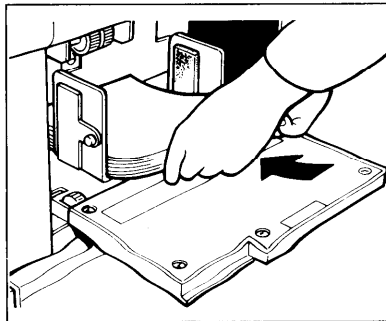

3. Load paper on the paper feed table.

- Release the pads of the feed side plates before loading paper. Reset the pads after paper is set.

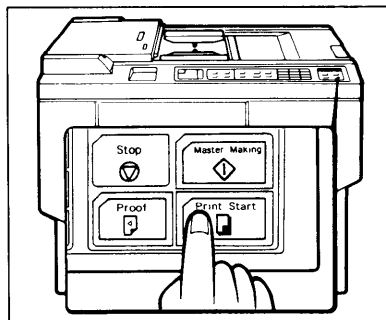

4. Press the **Print Start** key to resume printing.

2. Supplying Ink

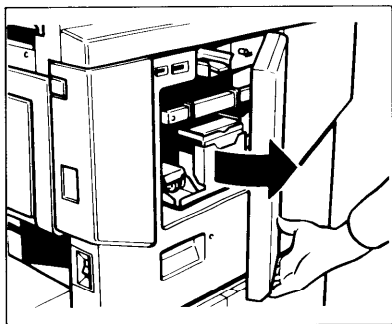

1. Open the front door.

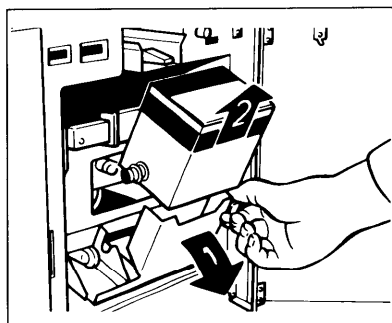

2. Lower the ink holder and remove the used ink cartridge.

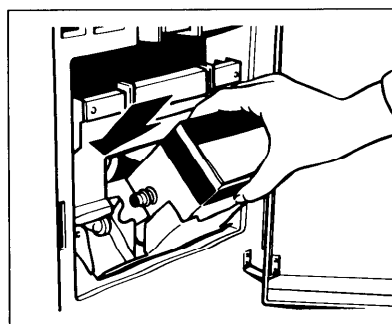

3. Remove the cap of the new ink cartridge and insert the new cartridge into the ink holder. Return the ink holder to its original position.

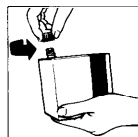

- Supply the same color ink.

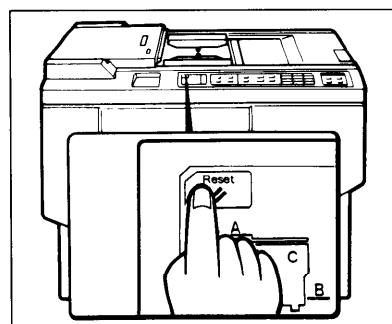

4. Close the front door.
5. Press the **Reset** key.

Ink will be supplied and the machine will stop automatically.

3. Master Roll Replacement

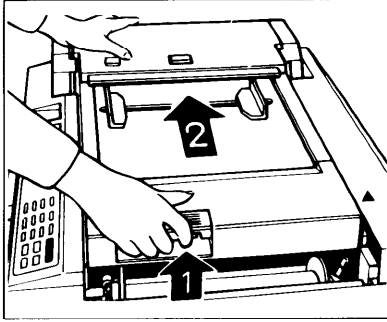

1. Open the original table.
 - Lift the original table release lever and slide the original table to the the "▼" mark.

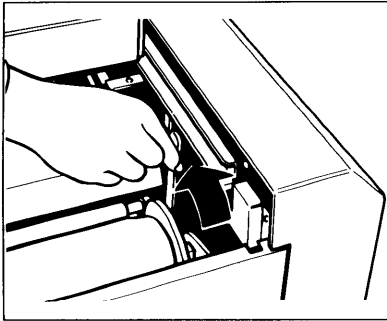

2. Lift the pressure release lever in the direction of the arrow to release the feed roller pressure.

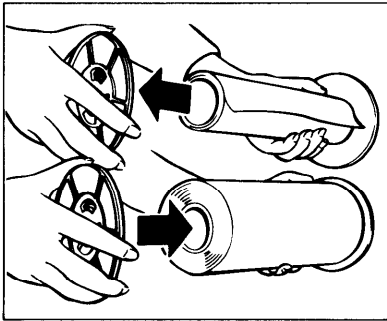

3. Remove the used master roll and pull out both spools. Then, insert both spools into a new master roll.
 - When the Master End Indicator lights, it is necessary to replace the master roll even if some paper remains on the old roll.

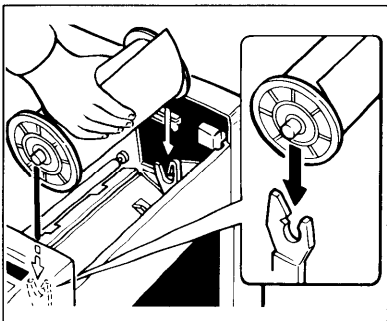

4. The new master roll must be positioned as shown in the illustration.

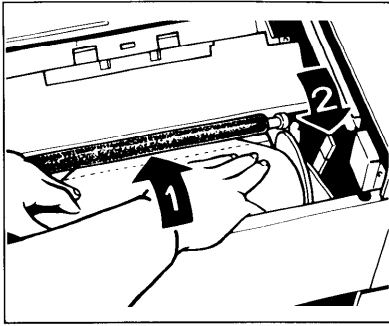

5. Insert the leading edge of the master roll under the pressure roller.(1)
6. Return the pressure release lever to its original position.(2)
 - Rotate the spools backward to take up all slack in the master paper.

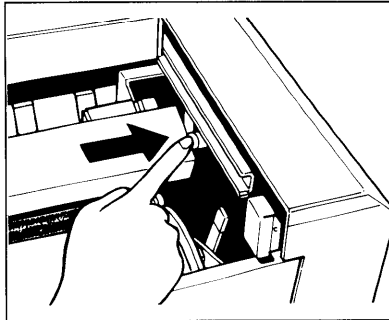

7. Press the master cut button to cut the leading edge of the master roll.

Warning: When the master cut button is pressed, the master roll will rotate. Do not touch the master roll.

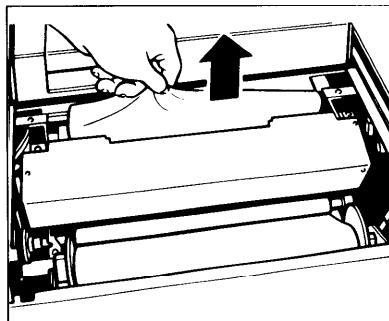

8. After the beeper sounds, remove the cut-off portion of the master roll.
 - Remove the cut-off master paper completely to prevent master misfeed.

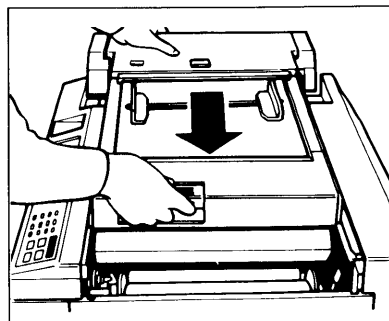

9. Return the original table to its original position until it stops.

MAINTENANCE

1. Thermal Head Cleaning

Clean the thermal head when 2 master rolls have been used.

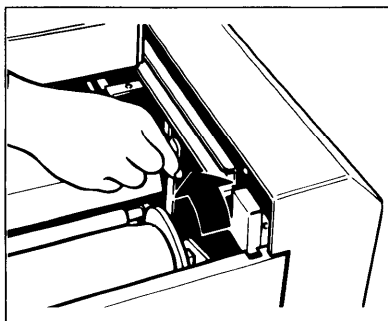

1. Turn off the main switch.
2. Open the original table. (See page 37.)
3. Move the pressure release lever in the direction of the arrow. (See page 37.)

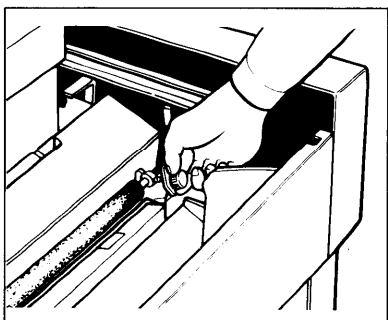

4. Loosen the screw knobs located on both sides of the feed roller.

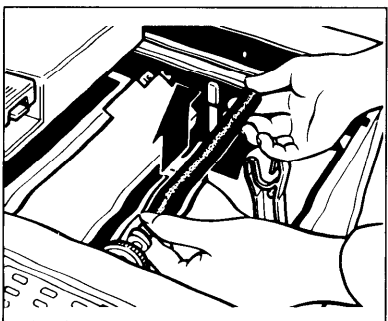

5. Grip both ends of the feed roller and lift it straight up.
6. Clean the thermal head as follows.
 - 1) Wipe the surface of the thermal head with a damp cloth.
 - 2) Clean the surface of thermal head several times using the cleaner pen with cleaning solution. (The cleaner pen is stored in the carton box as an accessory.)
 - 3) Dry the surface of thermal head with a clean dry cloth.

Warning: Make sure to replace the cap of cleaner after using it.

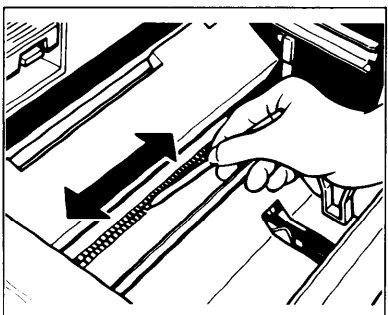

- Replace the felt of the cleaner pen if it becomes dirty.

7. Install the feed roller by reversing the above procedure.

2. Platen Cover • Exposure Glass • Mirror

To maintain a high copy quality, clean the following sections regularly.

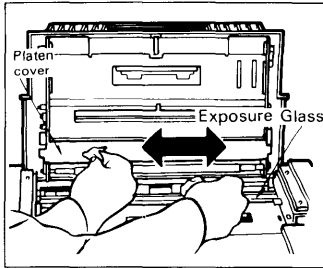

1. Platen Cover / Exposure Glass

- Clean the platen cover and the exposure glass with a soft cloth and a commercial glass cleaner.

Caution: Be careful not to touch the detect switch (white).

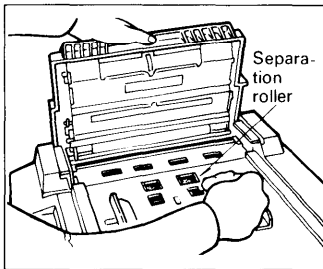

2. Mirror

- Blow dust from the mirror using the blower brush packed in the accessory box.

3. Clean the separation roller.

- While turning the rollers, clean them with a clean cloth.

How to open/close the ADF unit.

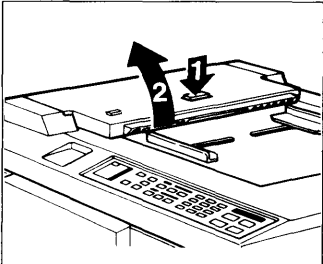

Opening

1. Open the ADF unit while pressing the ADF unit open button.

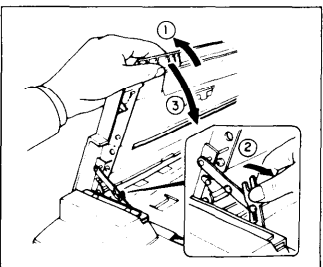

Closing















1. Raise the ADF unit slightly.
2. Pull the lock lever to the right.
3. Close the ADF unit.
 - Do not let go off the ADF unit until it is fully closed.

TROUBLESHOOTING

1. Indicators

If a malfunction or a misfeed occurs within the machine, the following indicators will light.

- Check the misfeed or malfunction location.

-  + **A** Open the ADF cover, remove original and reset. (See page 42.)
-  + **B** Remove the jammed paper and press the Reset key. (See page 43.)
-  + **C** Remove the jammed master and press the Reset key. (See page 44.)
-  + **E** Open the master eject unit and remove any jammed paper, then press the Reset key. If the paper is stuck to the drum:
 - 120V version: Remove the jammed paper while pressing the drum rotation button. (See page 45.)
 - 220/240V version: Pull out the drum unit until the drum unit hits the drum stopper, and remove the jammed paper from the drum. (See page 45.)
-  + **E + B**
 1. 120V version: Open the master eject unit and remove the jammed paper around the drum while pressing the drum rotation button.
 - 220/240V version: If the paper is stuck to the drum, pull out the drum unit until the drum unit hits the drum stopper, and remove the jammed paper from the drum.
 2. If the jam is in the paper feed section, the jammed paper may be cleared at either the paper entrance or the paper exit side. (See page 46.)
-  + **F** Open the master eject unit and remove the jammed master. Press Reset key. If the jammed master is stuck to the drum, pull out the drum unit and remove the misfed master. (See page 47.)
-  + **G** Open the master eject unit and remove the jammed paper. Press Reset key. (See page 47.)
-  + **A** Check that the original is correctly placed and that the counter is set for the required number of copies. (See page 48.)
-  + **B** Load paper. (See page 48.)
-  + **C** Load new master roll. (See page 48.)
-  + **D** Load new ink cartridge. (See page 49.)
-  + **F**
 1. Remove the used masters inside the master eject box.
 2. Make sure the master eject box is replaced correctly. (See page 49.)
-  Check the setting of the original table, the front cover, the master eject unit, the drum, the paper feed table, and the ADF unit. (See page 50.)
-  Color drum is installed. (See page 50.)
-  Set the key counter. (See page 50.)

If a service code (E01 – E07) is displayed in the counter, please contact your service representative.

2. When the Misfeed (Ⓜ) Indicator Lights

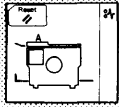

Ⓜ + A

Original misfeed / command sheet misfeed (SS950 only)

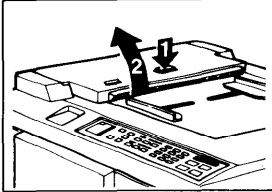

1. Press the ADF unit open button and open the ADF unit.

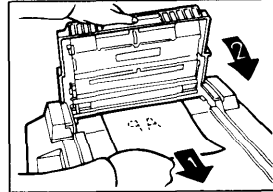

2. Pull out the original or the command sheet (SS950 only) gently.

3. Close the ADF unit.

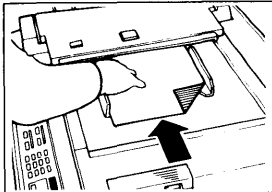

4. Reset the original face down on the original table.

5. Press the Reset key.

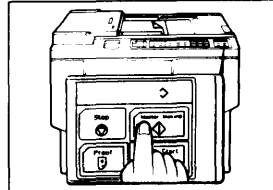

6. Press the Master Making key.

To prevent original misfeeds:

- Thin original → Make a copy
 - Thick original → Make a copy
 - Paste-up original → Make a copy
 - Folded or damaged originals → Make a copy
 - Originals larger than A3/11" x 17" → Make a reduced copy
 - Different kinds of original. (size, paper quality) → Set one original at a time
- Clean the separation roller if it is contaminated. (A contaminated separation roller may slip and cause original jams.)

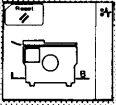

A + B

Paper misfeed in paper feed section.

When a sheet of paper is misfed:

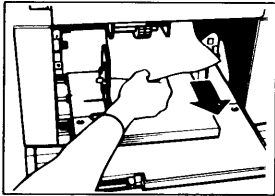

1. Remove the misfed paper.

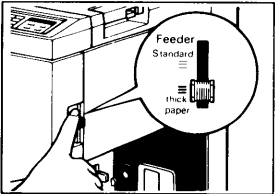

2. If the feed roller pressure lever is in the standard position, set it in the thick paper position.

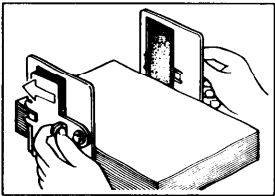

3. Release the side plate pads.

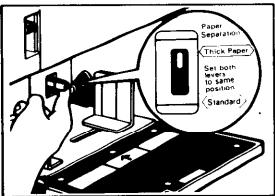

4. If the separation roller pressure lever is in the standard position, move it to the thick paper position.

5. Press the Reset key.

6. Press the Print Start key.

When two or more sheets are misfed:

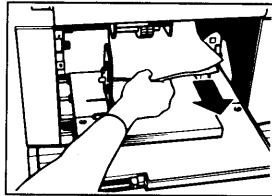

1. Remove the misfed sheets.

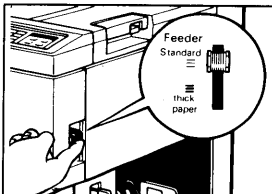

2. If the feed roller pressure lever is in the thick paper position, set it in the standard position.

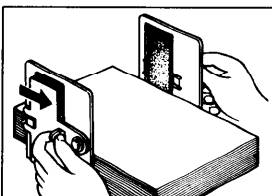

3. If the pad levers are positioned the left, move them to the right.

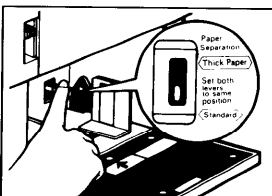

4. If the separation roller pressure lever is in the thick paper position, move it to the standard position.

5. Press the Reset key.

6. Press the Print Start key.

To prevent paper feed jams:

- Curled paper. → Correct the curl.

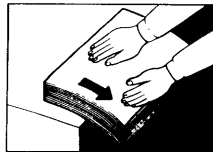

- Paper edges stuck together → Shuffle the paper



- Post card and thick paper. → Set the printing speed slower than step 3. (See page 25.)

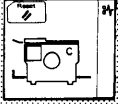

⌘ + C

Master misfeed in master feed section.

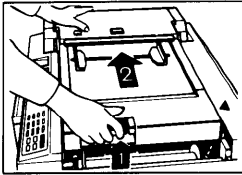

1. Slide the original table to the left while pulling up original table release lever.

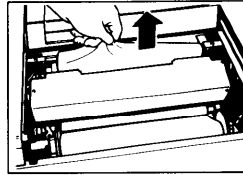

2. Remove the misfed master.
3. Slide the original table to the original position.

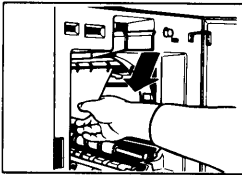

4. If you could not remove the misfed master in step 2, take out the drum and remove the misfed master from inside. (See page 27 to 28.)

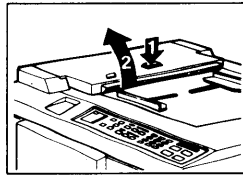

5. Open the ADF unit while pressing the ADF unit open button.

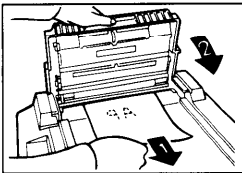

6. Slowly but firmly pull out the original.

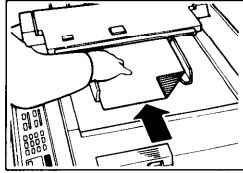

7. Re-insert the original in the ADF after closing the ADF unit.

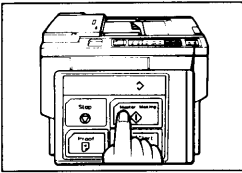

8. Press the Reset key.

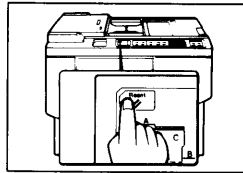

9. Press the Master Making key.

Check whether the master feed roller is installed properly when there is a master misfeed.

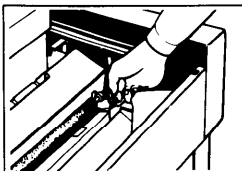

Check that the installation screws on both sides of the master feed roller are secured.

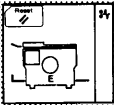

✚ + E

Paper wrapping around the drum.

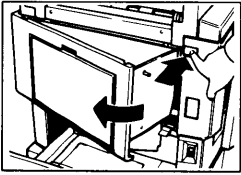

1. Push the master eject unit open button and open the master eject unit.

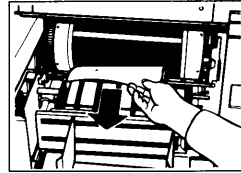

2. Remove the misfed paper.

120V version

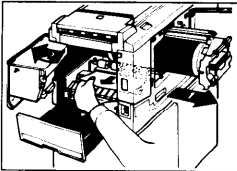

3. When paper is wrapped around the drum, open the front cover and remove the paper while rotating the drum by pressing the drum rotation button.

4. Close the front cover and the master eject unit.

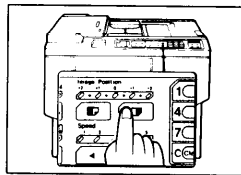

5. Prints which have an image on the leading edge tend to wrap around the drum easily. Shift the image toward to the trailing edge.

220/240V version

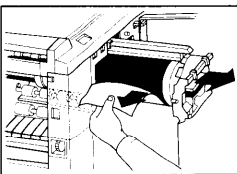

When paper is completely wrapped around the drum, pull out the drum unit until the drum hits the drum stopper, and remove the misfed paper from the drum.

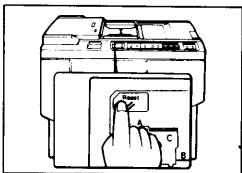

6. Press the Reset key.

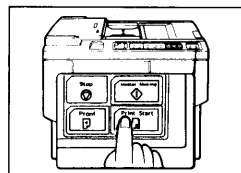

7. Press the Print Start key.

If the paper is curled or the original has narrow leading edge margin, the following action is necessary.

Curled Paper

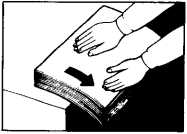
- Curled paper → Correct the curl. 
- Load the paper with the face curl down as shown in the figure.

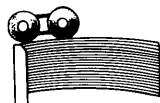

Narrow Leading Edge Margin Original

- Leading edge margin less than 10 mm. Solid fill image on the leading edge. → Insert the original with the widest blank margin first.
- Make a leading edge margin by making a copy.

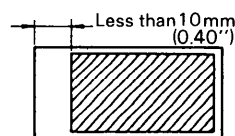

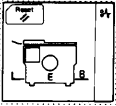

**A + E + B Misfeed in paper feed section.
Paper wrapped around the drum.**

• **Misfeed in paper feed section**

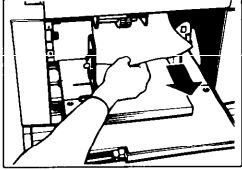

1. Slowly but firmly pull out the paper.

• **Paper is wrapped around the drum.**

120V version

Open the master eject unit and the front cover. Remove the paper while turning the drum by pressing the drum rotation button. (See page 45).

220/240V version

When paper is completely wrapped around the drum, pull out the drum unit until the drum hits the drum stopper, and remove the paper from the drum. (See page 45.)

• **When the misfed paper is underneath the drum.**

(Difficult to remove the paper from the paper feed section.)

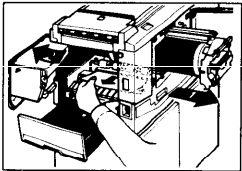

1. Pull out the drum until the drum unit hits to the drum stopper and remove the paper from the paper exit side.

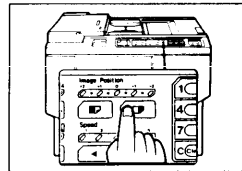

2. When the image is located on the leading edge, shift the image to the trailing edge by pressing the right image position key.

• (Also difficult to remove the paper from the paper exit section.)

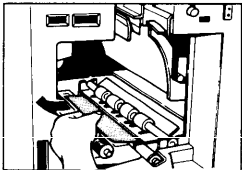

1. Take out the drum unit. Remove the misfed paper. (refer to page 27 to 28 for the drum removal)

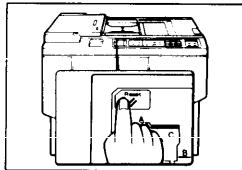

2. Press the Reset key.
3. Press the Print Start key.

If the paper is curled or the original has narrow leading edge margin, the following action is necessary.

Curled Paper

- Curled Paper

Correct the curl.

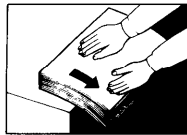

Load the paper with the face curl down as shown in the figure.

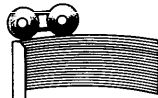

Narrow Leading Edge Margin

- Leading edge margin less than 10 mm. Solid fill image on the leading edge.

Insert the original with the widest blank margin first.

Make a leading edge margin by making a copy.

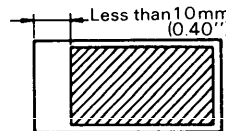

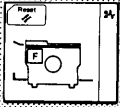

Ⓜ + F

Master misfeed in the master eject section.

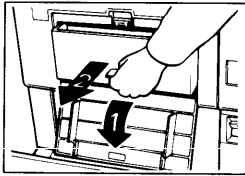

1. Open the master eject container cover and remove the master eject box.

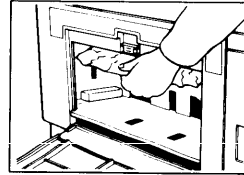

2. Remove the misfed master from master eject section.
3. Reinstall the master eject box and close the master eject container cover.

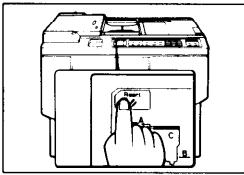

4. Press the Reset key.

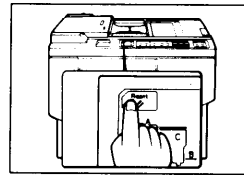

5. Press the Print Start key.

- When the master eject box is full, remove the used masters from the box.

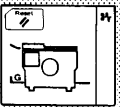

Ⓜ + G

Paper misfeed in the paper exit section.

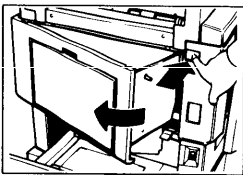

1. Open the master eject unit by pushing the master eject unit open button.

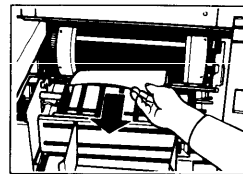

2. Remove the misfed-paper.
3. Close the master eject unit.

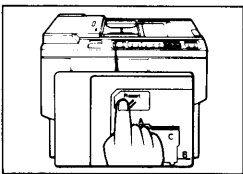

4. Press the Reset key.

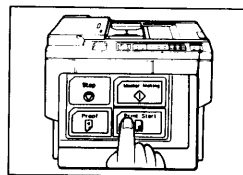

5. Press the Print Start key.

- If misfeeds occur while printing on thick paper, lift the wing guide release lever to the thick paper position. (Refer to page 21 for details.)

3. When the Supply/Exchange (⏏) Indicator Lights

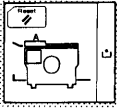

Originals are not properly inserted or the print number has not been input.

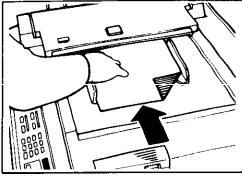

1. Insert the originals in the ADF unit.

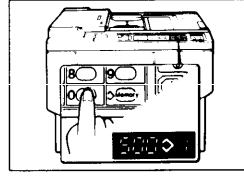

2. Input the number of prints using the Number keys.

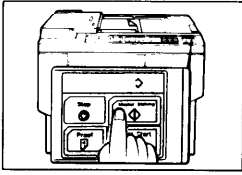

3. Press the Print Start key.

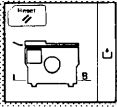

Paper End

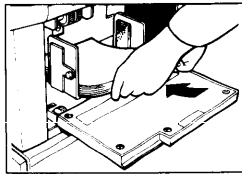

1. Load paper on the paper feed table. (See page 20.)

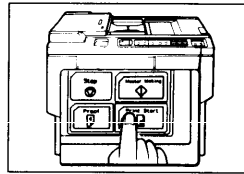

2. When the paper end occurs during a printing run, press the Print Start key again to resume printing.

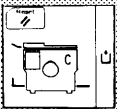

Master Paper End

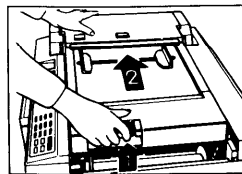

1. Slide the original table to the left by pulling up the original table release lever. Exchange the master roll. (Refer to page 37 for details.) Reset the original table after replacing the master roll.

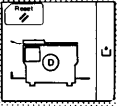

Add Ink

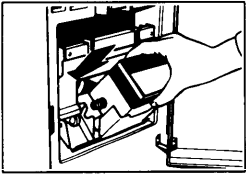

1. Open the front cover and replace the ink cartridge. (Refer to page 36 for the details.)

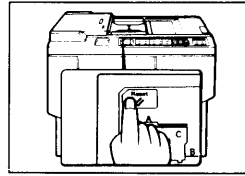

2. Press the Reset key.
 - Ink is supplied to the drum.
 - Press the Reset key again if the add ink indicator does not turn off.

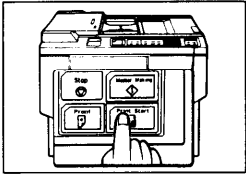

3. When the add ink indicator blinks during repeat printing, press the Print Start key again to resume printing.

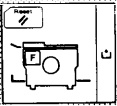

Master eject box full. Incomplete master eject box installation. No master eject box.

- When the master eject box is full, do the following:

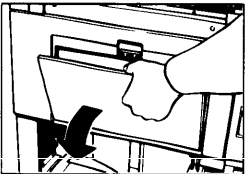

1. Open the master eject container cover.

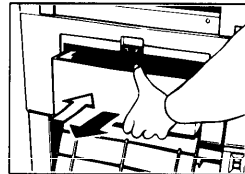

2. Take out the master eject box and remove the used masters.
3. Install the master eject box and close the master eject container cover.
4. Press the Reset key.

- Incomplete master eject box installation.

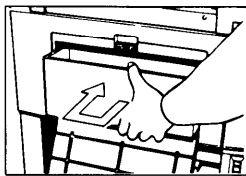

1. Open the master eject container cover.
2. Reinstall the master eject box.
 - Push the box so that it is in contact with the inside blacket.
3. Close the master eject container cover.

- No master eject box.

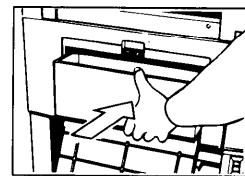

1. Open the master eject container cover.
2. Install the master eject box.

4. Other Indicators Light

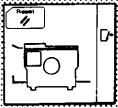

Cover Open / Unit Open

Make sure that the following covers/units are closed.

1. Original Table
2. Front Cover
3. Master Eject Unit
4. ADF Unit
5. Drum Unit
6. Paper Feed Table

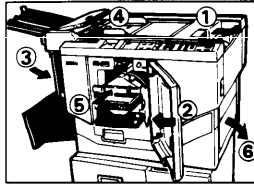

(Make sure that the paper feed table should be open.)

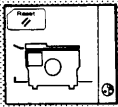

Color drum unit is installed.

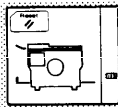

Key Counter:

The key counter is not set.

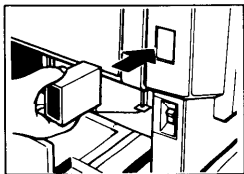

Insert the key counter.

When an error code (**E-01 – E-07**) is displayed, contact your service representative.

5. Dirty Printing

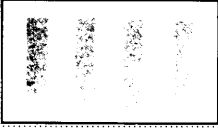

Dirty back of prints

← Feed Direction

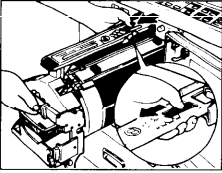

1. Remove the drum unit.
(Refer to page 27 to 28 for the details.)

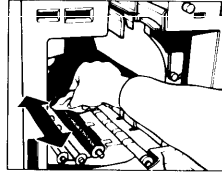

2. Clean the pressure roller with a clean cloth.

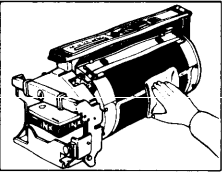

3. Clean the drum with a clean cloth.

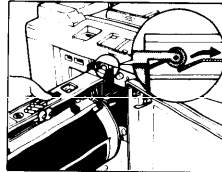

4. Install the drum unit.
(See page 27 to 28 for details.)

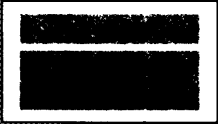

White Line / Black Line

← Feed Direction

Check following parts and clean them if contaminated.

- 1) ADF unit (see page 40.)
- 2) Exposure glass (See page 40.)
- 3) Thirmal head (See page 39.)

MISCELLANEOUS

1. Operating Cautions

1. If there is no blank area or a solid image area on the leading edge of the original, create a blank area because the paper may wrap around the drum or the paper eject pawl may become dirty and cause black line on prints.
2. When the paper is curled, stack the paper with the curl face down, otherwise the paper may wrap around the drum or stains may appear.
3. Make sure to make a few trial prints to check the image position because the image position of the trial print may not correspond with that of the original.
4. If the image registration is not consistent, set the printing speed slower than step 3.
5. The leading edge of the prints may become stained if the edge touches the image of prints on the paper delivery table.
6. In case of duplex or multicolor printing, leave the printed paper for a while before the next printing in order to dry the ink on the printed paper. If this is not done, feed roller marks will appear on the print image.
7. If the machine is not used for a long period, the image density may decrease because the ink on the drum may dry. Make extra prints until the image density recovers.
8. When the machine is used in low temperature conditions, the image density may decrease. In this case, decrease the printing speed (1 or 2 steps).
9. The ink of the print on the paper delivery table may stick to the back side of the next print.
10. When making duplex prints, misdetection of paper wrapping may occur because the paper delivery sensor detects the black area at the leading edge of the back side. Keep more than 10mm/0.4" blank area at the leading edge of the back side of the printing paper.
11. Do not use the thermal head cleaner for anything but cleaning the thermal head. Also, be sure to read the cautions about the thermal head cleaner, and be careful as this cleaner is a corrosive liquid.
12. When feeding B5/51/2"x81/2" paper in the sideways direction, the prints may not stack correctly on the paper delivery table. In this case, push up the wing guide release lever.

SPECIFICATION

Configuration:	Desk top
Master Processing:	Digital
Printing Process:	Full automatic one drum stencil system
Original Type:	Sheet
Image Mode:	Line/Photo
Color Printing:	Drum unit replacement system (red, blue, green, and brown) (option)
Master Feed/Eject:	Roll master automatic feed/eject
Original Size:	Maximum 307 mm x 432 mm (12.0" x 17.0")
Paper Size:	Maximum 297 mm x 432 mm (11.6" x 17.0") Minimum 90 mm x 140 mm (3.6" x 5.5")
Paper Weight:	50 to 215 g/m ² (13.3 to 57 lb)
Printing Area:	Maximum 250 mm x 350 mm (9.8" x 13.7")
Reproduction Ratio:	120V version: 100% → 93% → 75% → 64% 220/240V version 100% → 93% → 82% → 71%
Printing Speed:	5 steps: 40, 60, 80, 100, 120 sheets/minute
Paper Feed Table Capacity:	1,000 sheets (66.3 g/m ² /17.6 lb)
Paper Delivery Table Capacity:	500 sheets (66.3 g/m ² /17.6 lb)
Power Source:	120V, 60Hz, 5.5A 220/240V, 50/60Hz, 2.7A

Power Consumption: 120V version 430W
 220/240V version 470W

Dimensions (W x D x H): Printing: 1279 x 607 x 656 mm
 (50.4 x 23.9 x 25.9 inches)
 Storing: 735 x 607 x 577 mm
 (29.0 x 23.9 x 22.8 inches)

Weight: 120V version: 101 kg (222.7 lb)
 220/240V version: 106 kg (233.7 lb)

Optional Equipment: Color drum unit (red, blue, green, and brown)
 Key Counter

Consumables:

Name	Size	Remarks
Priport Master B4 Type 900	125m(410 ft)/roll 2 Rolls/case	250 masters can be made per one roll.
Priport Ink-Black	500 cc/pack 5 packs/case	Environmental conditions: 10 - 25°C, 20 - 90%RH Storage: 5 - 40°C, 10 - 95%RH
Priport Ink-Red	500 cc/pack 5 packs/case	
Priport Ink-Blue	500 cc/pack 5 packs/case	
Priport Ink-Green	500 cc/pack 5 packs/case	
Priport Ink-Brown	500 cc/pack 5 packs/case	
Thermal head Cleaner	Cleaner pen - 1pc Replacement Felt - 10 pcs Cleaner Bottle - 1pc	

- Specifications are subject to change without notice.